

# DRAINAGE STRATEGY REPORT



**ENERGY RECOVERY FACILITY**

**TEES VALLEY**

Doc Ref:

212018-DC-RP-C-01

JULY 2021



**Doran**  
**CONSULTING**

DELIVERING ENGINEERING EXCELLENCE

CONSULTING ENGINEERS

- » Civil Engineering
- » Structural Engineering
- » Traffic and Transportation
- » CDM Co-ordination
- » Project Management

Electronic Copy

**DORAN CONSULTING LTD**

## **DRAINAGE STRATEGY REPORT**

**Energy Recovery Facility, Tees Valley**  
**Doc Ref: 212018-DC-RP-C-01**

July 2021

<b>Job no</b>	<b>Prepared by</b>	<b>Checked by</b>	<b>Approved by</b>	<b>Status</b>	<b>Issued to</b>	<b>No of copies</b>	<b>Date</b>
212018	OC	AC	PGK	Issue 01	FCC	*e	09.07.21
212018	ENJ	AC	PGK	Issue 02	FCC	*e	11.08.21
212018	AC	AC	PGK	Issue 03	FCC	*e	23.08.21
212018	MKP	AC	PGK	Issue 04	FCC	*e	28.01.22
212018	EF	AC	PGK	Issue 05	FCC	*e	01.04.22
212018	EF	AC	PGK	Issue 06	FCC	*e	06.04.22
212018	JPS	AC	PGK	Issue 07	FCC	*e	15.02.23

---

Doran Consulting Limited  
Registered Office  
Norwood House  
96-102 Great Victoria Street  
Belfast BT2 7BE

**T** 028 9033 3443  
**F** 028 9023 5501  
**E** mail@doran.co.uk  
**W** www.doran.co.uk



FS 25466  
OHS 507887  
EMS 75248



consultancy engineering business environment

NI Reg No. NI055181

## CONTENTS

1.0	INTRODUCTION .....	4
2.0	AIM OF THE REPORT .....	5
4.0	EXISTING DRAINAGE .....	8
5.0	PROPOSED SURFACE WATER DESIGN STRATEGY .....	9
6.0	PROPOSED FOUL WATER DESIGN STRATEGY .....	16
7.0	DRAINAGE OPERATIONS AND MAINTENANCE REQUIREMENTS .....	18
8.0	MAINTENANCE PROCEDURES AND ACCESS .....	19
9.0	PHASING OF PROPOSED DRAINAGE SYSTEMS.....	21
10.0	CONCLUSIONS AND RECOMMENDATIONS.....	22
	APPENDIX A.....	
	APPENDIX B.....	
	APPENDIX C .....	
	APPENDIX D .....	
	APPENDIX E.....	
	APPENDIX F .....	
	APPENDIX G .....	

## 1.0 INTRODUCTION

Doran Consulting Limited (DCL) have been commissioned to provide a surface and foul water drainage strategy and design for a proposed Energy from Waste (EfW) Facility to be located at Grangetown, on land within the South Tees regeneration area (also known as “Teesworks”) Redcar, Teesside.

The proposed EfW development is located to the south of the Tees Valley rail line and north of the Eston Road-A66 junction on land which previously formed part of the wider Redcar Steelworks complex. A proposed development layout is included as Appendix A.

The site can be found at UK grid reference E454383 N521138.

The development of the Energy Recovery Facility which will consist of the following main elements;

- Tipping hall
- Waste bunker
- Boiler
- Flue gas treatment area
- Stack
- Turbine hall
- Air cooled condenser
- Bottom ash storage
- Administration facilities
- Control room
- Workshop
- Weighbridge and gatehouse
- Car parking
- Fire-fighting water tank and associated equipment
- Waste transfer station
- Areas set aside for future Carbon Capture and Storage

Roads, infrastructure and areas of landscaping in association with the EfW are also proposed.

## 2.0 AIM OF THE REPORT

The aim of this report is to present the proposed below ground surface water and foul water drainage design for the Tees Valley Energy from Waste Facility.

Specifically, the report has been computed in order to satisfy Planning Conditions stipulated by the Local Planning Authority, Redcar and Cleveland Council, for planning permission Ref R/2019/0767/OOM.

### 3.0 PLANNING CONDITIONS

The following planning conditions have been imposed upon the proposed development in relation to the design of the proposed drainage systems.

#### 3.1 Condition 8: Foul water disposal

*Development shall not commence until a detailed scheme for the disposal of foul water from the development hereby approved has been submitted to and approved in writing by the Local Planning Authority in consultation with Northumbrian Water and the Lead Local Flood Authority. Thereafter the development shall take place in accordance with the approved details.*

#### 3.2 Condition 9: Surface water drainage scheme

*Prior to the commencement of the development or in such extended time as may be agreed in writing with the Local Planning Authority, details shall be submitted and approved of the surface water drainage scheme and the development shall be completed in accordance with the approved scheme.*

*The design of the drainage scheme shall include:*

- i) Restriction of surface water greenfield run-off rates (QBAR value) with sufficient storage within the system to accommodate a 1 in 30-year storm.*
- ii) The method used for calculation of the existing greenfield run-off rate shall be the ICP SUDS method. The design shall so ensure that storm water resulting from a 1 in 100-year event, plus climate change surcharging the system, can be stored on site with minimal risk to persons or property and without overflowing into drains, local highways or watercourses.*
- iii) Full Micro Drainage design files (mdx files) including a catchment plan;*
- iv) The flow path of flood waters for the site as a result on a 1 in 100-year event plus climate change*

#### 3.3 Condition 10: Surface Water Drainage Management Plan

*Prior to the commencement of the development, or in such extended time that may be agreed with the Local Planning Authority, details of a Surface Water Drainage Management Plan shall be submitted and approved by the Local Planning Authority. The Management Plan shall include:*

- i) The timetable and phasing for construction of the drainage system*
- ii) Details of any control structure(s)*
- iii) Details of surface water storage structures*

- iv) *Measures to control silt levels entering the system and out falling into any watercourse during the construction process. The development shall, in all respects, be carried out in accordance with the approved Management Plan.*

#### 3.4 Condition 11: Surface Water Management and Maintenance Plan

*The development shall not be occupied until a Management & Maintenance Plan for the surface water drainage scheme has been submitted to and approved by the Local Planning Authority; the plan shall include details of the following:*

- i) *A plan clearly identifying the section of surface water system that are to be adopted.*
- ii) *Arrangements for the short and long-term maintenance of the SuDS elements of the surface water system.*

## 4.0 EXISTING DRAINAGE

The development site currently consists of derelict land and abandoned surface and sub-surface structures. It could therefore be considered as brownfield development with 100% impermeable surfacing. It is understood that site clearance and remediation works are currently being undertaken. In relation to the proposed design of site drainage systems, the site shall be considered as a greenfield development.

### 4.1 Existing Drainage Flow Rates

Calculations were undertaken to determine the equivalent greenfield run off rate from the site for varying storm events. A summary of the results are presented in Table 4.1. (Please note that the below figures have been calculated based upon a proposed site area of 9.105ha. This extent is noted to be less than that considered at planning stage within the JBA Consulting Flood Risk Assessment, December 2019; which had also included the new external highway extents within their calculations. This report considers the proposed drainage provisions within the site boundary only. It is noted that drainage provisions within the adjacent highway infrastructure shall be considered by others).

Table 4.1: Greenfield Runoff Rates

Storm Event	Rate of Surface Water Run off (l/s)
Q1	31.6
Q30	58.8
Q100	69.5
QBAR	33.4

### 4.2 Existing Drainage Infrastructure

It is understood that any private drainage within the site has been abandoned or removed as part of enabling and remediation works undertaken. It is therefore considered that the site is not currently drained. The site has however been understood to previously drain to the adjacent Holme Beck culvert, which runs northwards along the western site boundary, in turn out-falling to the Cleveland Channel and onwards to the tidal Tees estuary.



## 5.0 PROPOSED SURFACE WATER DESIGN STRATEGY

Surface water generated from the proposed development site shall discharge to the realigned Holme Beck culvert (controlled surface water) at a controlled rate. The design of the proposed surface water drainage system has been undertaken to provide a sustainable solution, reducing the surface water outflow from the proposed site to the equivalent predevelopment QBAR flow, calculated to be 33.4 l/s. Surface water flows shall be throttled via the provision of a vortex flow control and an attenuation basin. The total volume of attenuation to be provided within the surface water drainage system has been calculated to be circa 4,000 m<sup>3</sup>. The system has been designed to accommodate storm return periods up to and including the 1 in 100 year event plus 20% climate change allowance.

### 5.1 General Drainage Design Parameters

Based on the criteria set out in national standard and assessment methods and design methods considered best practice, the following parameters have been applied to drainage elements:

- In a 1 in 5 year storm event, surface water pipes can run at full capacity with no surcharging.
- In a 1 in 30 year storm event, the surface water system can surcharge but will not flood.
- In a 1 in 100 year storm event, the surface water system can surcharge but will not flood.
- In a 1 in 100 year storm event (with applied percentage increase of 20% for the allowance of climate change), flooding is to be retained and managed on the site to protect properties and ensure safe access and egress.
- Surface water flows shall be subjected to a SuDS Management Train in accordance with current best practice and the SuDS Manual – CIRIA C753.
- Where possible, drainage design should work towards mimicking greenfield run-off situations.

### 5.2 Surface Water Drainage Objectives and constraints

Planning condition no.9 of R/2019/0767/OOM requires that the site should work towards mimicking greenfield run off situations and restricting the discharge rate to the equivalent QBAR flowrate. In an ideal situation this can be achieved by the implementation of surface water source control measures such as infiltration systems, swales, filter strips and permeable paving.

Site investigations including boreholes and trenches have identified that drainage infiltration techniques for the proposed site shall not be appropriate. As an alternative and to reduce the rate of surface water run-off from the site, it is proposed that surface water attenuation measures can be employed to limit the rate of discharge to a sustainable level.

A SuDS management train shall be developed for the project, in accordance with the SuDS Manual, and should include a range of source control measures to limit the impact of the development on the local environment and watercourse.

### 5.3 Proposed Surface Water Design Strategy

A surface water drainage design has been undertaken for the project and detailed drawings prepared.

As discussed in Section 5.2, the site is not suitable for the use of infiltration techniques.

It is proposed that surface water will be collected from the various buildings and paved areas across the site via a range of rainwater pipes (both gravity and siphonic), gullies, drainage channels, and permeable surfaces. The surface water generated will then be routed through a proposed attenuation basin to be located within the southern landscaping area of the development. The proposed basin will serve the entirety of the proposed site. It is proposed that the volume to the attenuation basin shall be c. 6,000 m<sup>3</sup> (4000m<sup>3</sup> of surface water attenuation required). Where possible, separate pipework systems shall be provided for roof water and surface water collections. Surface water systems shall be conveyed through appropriately sized oil separators, whereas roof water shall discharge directly to the Suds basin.

Flow restriction downstream of the attenuation shall be achieved via the provision of a vortex flow control unit, with associated online surface water storage provided by the online attenuation basin.

A rainwater harvesting system shall also be provided. The harvested water is primarily envisaged for use within the administration facilities to effectively lessen the demand for potable water (WC flushing etc.). Harvested water will however also be made available for process input should the requirement arise.

Figure 5.1 presents a summary of the various surface water drainage features being included as part of the design.

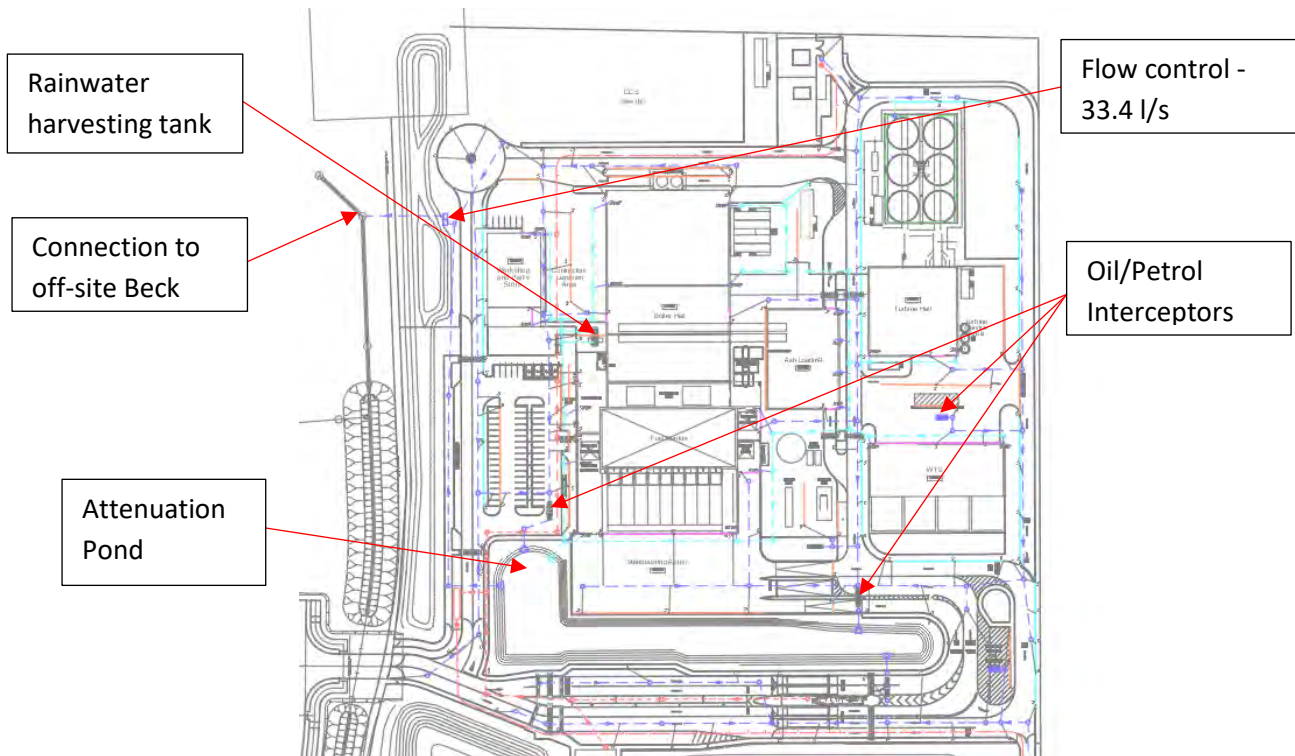

Figure 5.1 – Proposed Surface Water Drainage Strategy

#### 5.4 Proposed Out Flow

Flow from the surface water attenuation system shall be limited used a vortex flow control unit, to a flow rate of 33.4 l/s in accordance with the planning condition no. 9(ii).

All surface water calculations are appended to this report for information. All calculations consider storm events up to and including the 1 in 100 year return period of critical duration and also include a 20% allowance for climate change in accordance with current best practice guidelines.

#### 5.5 Out of Sewer Flooding in Q100 Design Rainfall Event

Planning condition no. 9 (R/2019/0767/OOM) requires that sufficient storage be provided within the surface water drainage systems to accommodate a 1 in 30 year storm event. The condition further requires that any excess surface water be retained onsite during a 1 n 100 year event (plus climate change).

Due to the sensitive nature of site activities, the presence of electrical equipment and the routing of vehicles across the site, it has been proposed, adopting a more conservative approach, that the surface water attenuation system be constructed to be large enough to

accommodate the 1 in 100 year storm event (+CC) with minimised system surcharge (i.e. minimal out of sewer flooding during the Q100 design storm event). Figure 5.2 below illustrates the estimated out of sewer flooding (modelled using Micro-drainage Floodflow software) within the Q100 design event. Out of sewer water is shown to accumulate along drainage valley locations, such as gully/channel positions, which shall in time drain back into the below ground system and the storm event subsides.

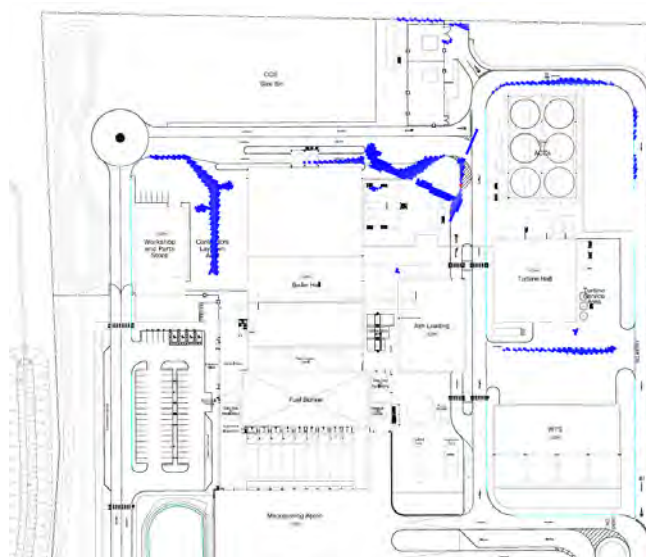

Figure 5.2 – Out of Sewer Flooding During 1 in 100 year (+CC) Storm Event

## 5.6 Drainage to Oil/Ammonia Delivery Area

There are oil and ammonia storage tanks noted to be sited externally within the proposed development. A dedicated delivery area shall be provided within the external area adjacent to the tanks. It is noted that these areas will be particularly sensitive and will require an innovative drainage solution. The solution proposed comprises of a dedicated drainage channel/gully system, which isolates the delivery area (tanker parking area) from the adjacent hardstanding drainage system. Surface water collected from this area shall drain through a valve chamber, whereby flows can be directed to a remote below ground storage tank (7,000litre Tankstor 200 series tank by SPEL or similar approved), during periods of delivery. In the unlikely case where a spillage occurs during delivery, the contents of the spill will then be collected within the storage tank, which has sufficient capacity to accommodate the volume of a full tanker compartment. The tank can then be pumped out by a specialist tanker and disposed of offsite.

Articulated tanker trucks will vary in size and have a typical capacity no greater than 36,000 litres. Tankers are split into separate storage compartments, typically between 5-7no. compartments depending on the size of the tanker, with each compartment typically no greater than approximately 6000 litres. The proposed tank solution is therefore considered to provide sufficient capacity to cater for the loss of 1no. tanker compartment whilst also accommodating concurrent rainwater storage, in line with best conservative industry practice.

## 5.7 Drainage to External Storage Bunds

Electrical transformers (substation) as well as oil and ammonia storage tanks shall be installed within external reinforced concrete retention bunds. The structures will retain any contamination in the event of a leakage etc. Rainwater falling within the bunds shall also be collected and retained, until it is released via sump pumps, in a duty standby arrangement to the adjacent surface water drainage systems. Oil detection sensors, will be provided where applicable (transformer and oil storage bunds only) which will prevent the pumps from operating in the event of an oil spill. This system aims to maintain the integrity of the fuel bund and prevents uncontrolled escape of oil. Rainwater released in this manner shall drain to the surface water drainage system and ultimately pass through an oil separator, prior to discharge to the public sewer network. Float switch activated alarms within the bunds shall be provided to alert that a high water level is present within the bund. However, it is recommended that the bund is regularly inspected (daily if possible) as part of the site management procedures. Water collected within the Ammonia tank bund will need to be pumped manually from the bund, upon inspection.

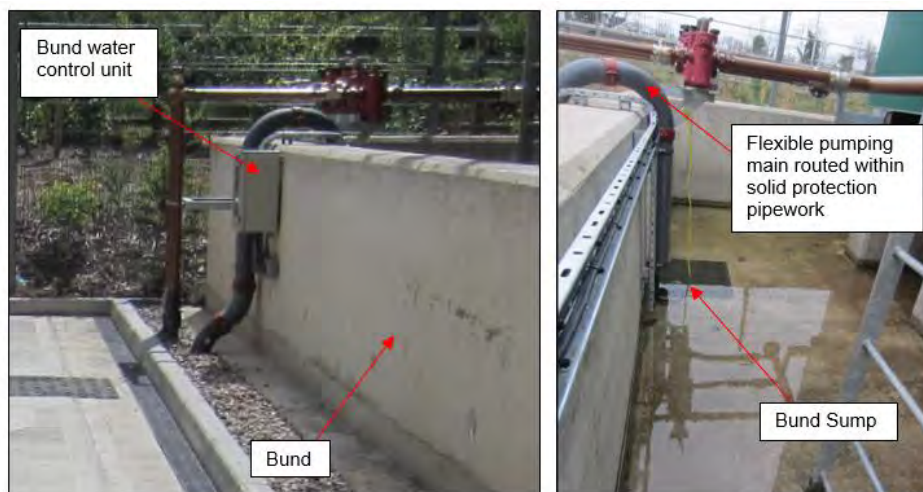

Figure 5.3: Bund Water Control Unit

## 5.8 Sustainable Drainage Systems

### 5.8.1 Source Control

As discussed in Section 5.2, the scope for the implementation of source control is greatly reduced due to restrictions on infiltration techniques and the proposed heavy goods vehicle site use etc. Suitable source control methods have been identified and are to be provided in the SuDS management train to be incorporated in the development, where appropriate:

- **Permeable Surfacing**  
The use of permeable paving systems in car parking areas shall be encouraged to provide water retention and effectively slow down the release to the positive drainage system.
- **Attenuation Basin**  
It is proposed to provide an online attenuation basin in the south of the site to provide surface water retention. A section of the basin shall have a permanent water volume provided, which shall also serve to treat the surface water routed through the basin by promoting the settlement of suspended siltation from the water.

### 5.9 Water Quality Protection

All discharge from the proposed development will pass through oil/petrol interceptors and the attenuation basin prior to out-falling into the public sewer system. Silt pit manholes shall also be provided across the surface water drainage network to intercept suspended silt close to source. A section of the proposed attenuation basin shall also have a permanent water level, to aid in the treatment of surface water by providing opportunity for suspended silt to settle, prior to discharge from the site.

In addition, a range of pollution prevention measures shall be incorporated including oil separators, bespoke drainage solutions for oil/chemical delivery and storage areas and an automatic site shut-off valve to allow the site drainage system to be isolated from the receiving watercourse during a potential pollution event.

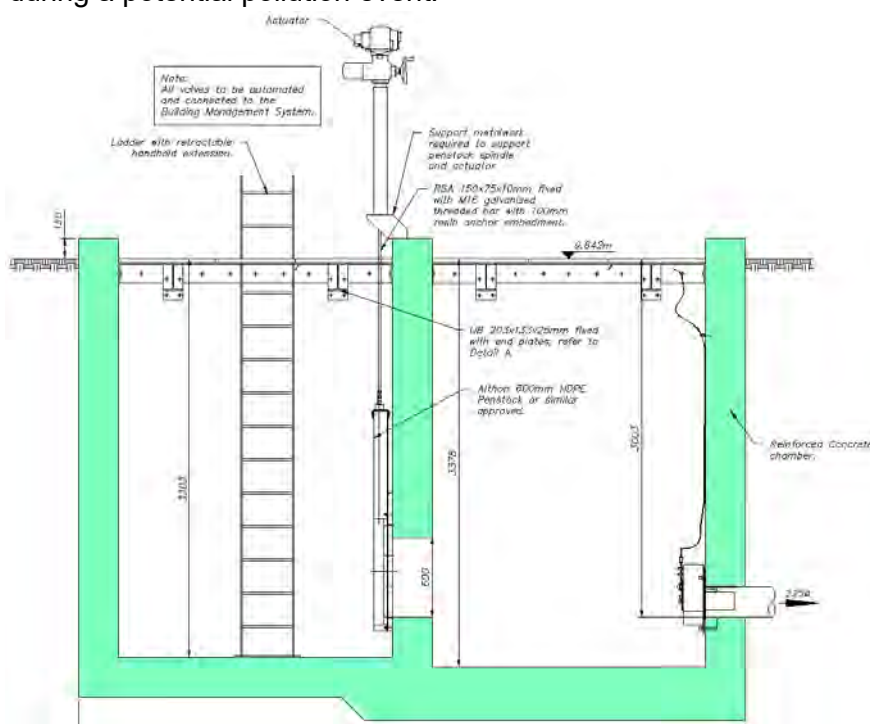

Figure 5.4: Combined Pollution Prevention Shut-off Valve & Flow Control Chamber

In addition to this there are two emergency hot load discharge areas, surface water run-off in these areas is to discharge to a manhole containing a 3-way valve. In the event that the area is being used to fight fire the valve is to be turned and the spent firewater is to discharge to a dump tank.

#### 5.10 Process Water Systems

Effluent, process water, wash-down water and potential contaminated surface water will be generated from the proposed site activities. A dedicated closed drainage system shall be provided to accommodate process water requirements. Process water shall be collected via a series of internal floor drains and pits.

Process drainage pipework shall be designed to cater for high temperatures and chemical composition as per process requirements. The areas where such drainage systems will be required are as follows:

- Boiler Hall
- Turbine Hall
- Flue Gas Treatment (FGT) Area
- Ash Storage Areas
- Residue Silo areas

Process water and wash down, collected within the floor drain system, shall be discharged to a central sedimentation/settling tank. Water shall then be recycled from the tank and re-used within the process systems.

## 6.0 PROPOSED FOUL WATER DESIGN STRATEGY

The proposed development will see the construction of a new Energy from Waste facility with associated welfare and sanitary requirements. The foul water generated from these facilities will be collected via a proposed foul drainage system and discharged to a pumping station. The pumping station will pump flows to a decompression chamber, located at the emergency exit from the site and in turn convey flows to an existing 150mm diameter foul sewer via gravity. The pumping station will contain a storage tank with a capacity of 62,000L, providing 24 hour storage in the event of a pump failure.

A small pumping station will be required to serve facilities located at a remote northern section of the site away from the proposed foul drainage system. The pumping station will pump flows to the proposed foul drainage network.

The foul drainage system has been designed to the relevant British Standards for the appropriate flow from the various sections of building and complies with the appropriate local building regulations. Maintenance of pumping stations shall be undertaken at regular intervals as part of the general drainage maintenance programme for the development.

The proposed foul drainage system is designed to convey peak flows from the proposed facilities. Gravity sewers are designed at gradients sufficient to give self-cleansing velocities within the pipes during times of peak flows. This will help reduce maintenance and prevent blockages within the network.

Manholes are typically to be constructed using precast concrete runs with 600mmx600mm clear opening access covers. Smaller brick-built chambers and polypropylene inspection chambers may be required in areas where space is limited. External pipework shall be of Vitrified Clay. All pipework, located within the building footprint (both main sewers and connections) shall be cast iron and, where appropriate shall be suspended from the above floor slabs. All manholes located within the building footprint shall be of reinforced concrete construction and made integral with the surrounding floor.

Figure 6.1 presents a summary of the various foul water drainage features being included as part of the design.



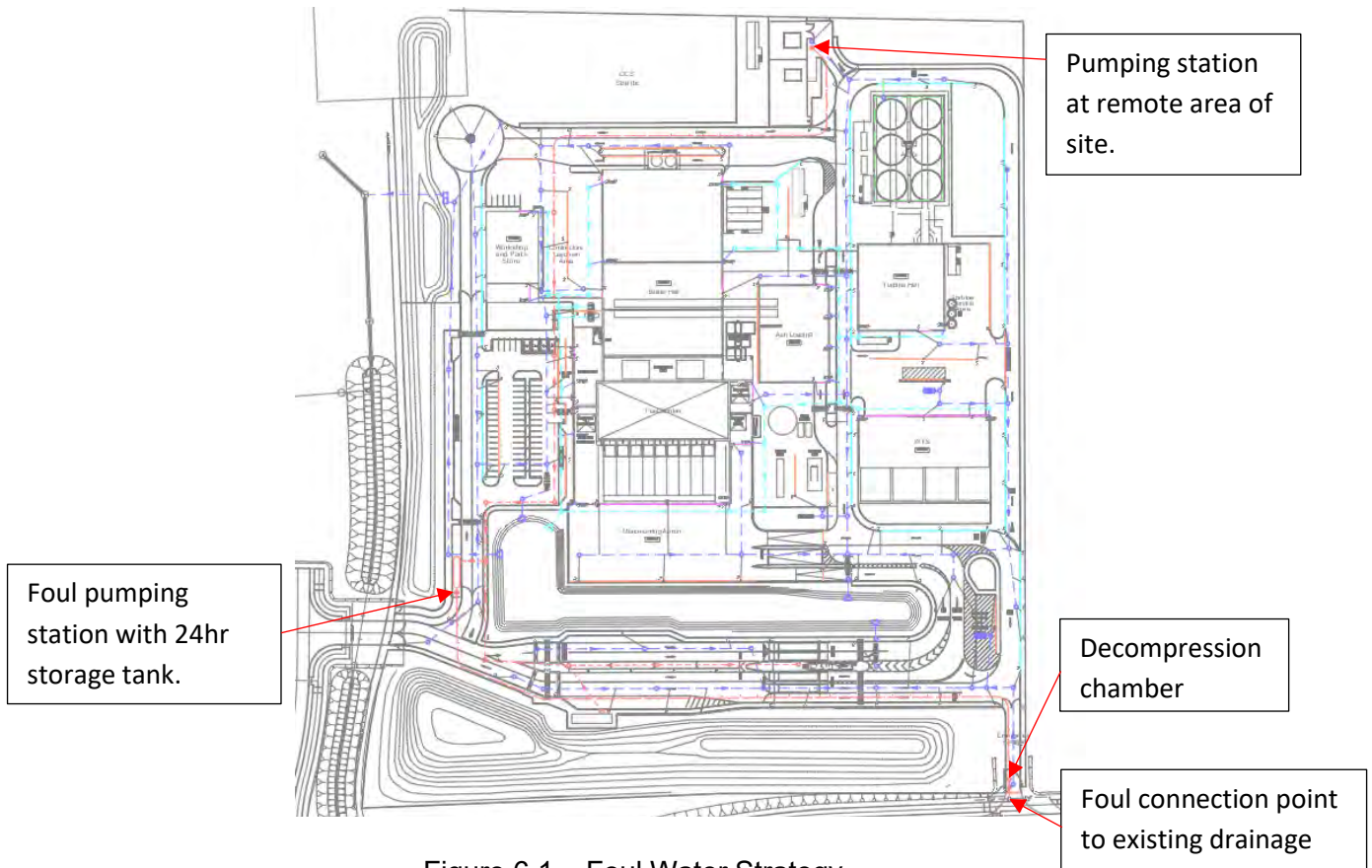

Figure 6.1 – Foul Water Strategy

## 7.0 DRAINAGE OPERATIONS AND MAINTENANCE REQUIREMENTS

The following components are proposed to be incorporated within the development's surface water drainage design:

- Attenuation Basin
- Permeable Surfaces
- Gullies
- Drainage Channels
- Silt Pits
- Petrol Interceptors
- Vortex Flow Control Unit
- Pollution Prevention Shut-off Valve
- Dump tank

Operation and maintenance requirements for each of these components are described in the table at the end of this document (Appendix G). It is imperative that systems are adequately maintained as failure to do so may result in reduced capacity/efficiency or a complete systems failure.

The tables provided within Appendix G are noted to present the long term or operating maintenance requirements. Short term requirements shall be applicable during the construction phase of the project, whereby the contractor shall assume responsibility for the cleaning, operation and maintenance of the drainage elements until completion of the project.

## 8.0 MAINTENANCE PROCEDURES AND ACCESS

The following section aims to outline the below ground drainage elements within the proposed scheme, identifying where they are to be located, how they are to be maintained and any special access requirements that may be required as part of their maintenance procedures.

### 8.1 Attenuation Basin

An online attenuation basin is proposed to attenuate surface water flows generated from the site before being discharged offsite. It is proposed to locate the basin within an area of landscaping in the south of the site with a series of precast concrete headwalls located around the perimeter. Access for maintenance and inspection shall be provided via suitable means such as steps and dedicated footway.

### 8.2 Permeable Surfaces

Permeable surfaces are promoted across the main staff car park to collect and provide source control of surface water. Access for maintenance and jetting can be done via surface access and access units, which shall be strategically placed to serve this function.

### 8.3 Gullies and Drainage Channels

Gullies and drainage channels are proposed across the scheme to collect surface water. Access for maintenance, inspection and jetting shall be provided via dedicated access and sump units. Rodding, CCTV and jetting can be fed in through the access units, which shall be strategically placed to serve this function.

### 8.4 Silt Pit Manholes

Silt pit manholes shall be provided throughout the scheme. These shall consist of precast concrete chambers with a 300mm sump at the base to allow the interception of silt and debris within the surface water drainage system. The silt pits shall be regularly cleaned out in accordance with the schedule at the end of this document. The silt pits shall be located in areas which are fully accessible.

### 8.5 Oil/Petrol Interceptors

There are 5 no. oil/petrol interceptors to be installed upstream of the basin outfall headwalls. The interceptors are to be located in areas easily accessible by jet-vac vehicles for maintenance purposes.

## 8.6 Vortex Flow Control Unit & Pollution Control Valve

The vortex flow control is proposed as a hydrobrake unit or similar approved with a manual drain-down facility. The flow control is proposed to be located within a dedicated reinforced concrete chamber. The chamber shall also house a site pollution control penstock type valve, which shall effectively be able to isolate the site drainage system from external receiving watercourses during a pollution event onsite. The chamber shall have an open mesh floor for easy visual inspection and wash down and shall be accessed via the lifting of a cover and retractable ladder facility. Silt and debris shall be removed in accordance with the schedule at the end of this document.

## 8.7 Sewers Located Below Building Footprint

There are a number of drainage sewers proposed to be installed beneath the proposed building to convey foul drainage flows into the sitewide systems from the process drainage network and sanitary drainage.

The installation of the drainage below the building footprint shall be undertaken in a considerate and sensitive manner. The drainage shall consist of robust materials, class H concrete or cast iron. The integrity of the drainage shall be checked at time of construction and again prior to installation of the ground floor slabs via CCTV surveys. Rodding, jetting and CCTV access shall be provided via manholes.

## 8.8 Dump tanks

There are 2 no. dump tanks to be installed next to the emergency hot load discharge areas. The dump tanks are to be emptied after any firefighting event and disposed off in accordance with local legislation.

## 9.0 PHASING OF PROPOSED DRAINAGE SYSTEMS

The phasing of the drainage installation across the site shall be developed in agreement with the proposed contractor for the works.

A construction phase drainage system shall be designed to serve the site during initial earthworks phases and shall be adapted and reconfigured to suit as the works are progressed. It is envisaged that the attenuation basin shall be formed (at least in part) early within the works and shall be used to serve the construction phase as well as the permanent works. The flow control/pollution prevention chamber shall also be provided early within the scheme to allow connection to the external Holme Beck culvert infrastructure and provide the required flow restrictions etc. during the construction phase of the works.

External hardstandings etc. are envisaged to be largely completed prior to erection of plant within the buildings, providing adequate preassembly and laydown facility. The associated surface water systems shall thus be provided prior to the areas being completed.

Process drainage shall be encompassed within the proposed floor slabs across the facility and shall be constructed in tandem with the installation of the concrete slabs and foundations.

Temporary de-siltation measures such as weirs within the basin/pond and potential silt buster plant etc. shall be provided until such time as the construction works are completed. For further information, please refer to the Construction Environmental Management Plan (CEMP).

## 10.0 CONCLUSIONS AND RECOMMENDATIONS

The aim of this report has been to present the proposed below ground surface water and foul water drainage design for the proposed Tees Valley Energy from Waste facility, Grangetown. Specifically, the report has been compiled in order to satisfy planning conditions no. 9, 10, and 11 as stipulated by the Local Planning Authority, Redcar and Cleveland Council for planning permission Ref R/2019/0767/OOM.

The proposed surface water and foul water drainage systems have resulted in sustainable and robust drainage systems.

Surface water flows from the proposed development are proposed to discharge to the adjacent controlled surface watercourse. Flows have been limited to 33.4 l/s during a 1 in 100 year storm event (+20% climate change). This maximum run-off equates to the QBAR surface water run-off rate from the equivalent greenfield pre-development site.

In addition, a range of SuDS measures are proposed to ensure that surface water is safely attenuated on site during a 1 in 100-year storm event with a 20% allowance for climate change; and any impact from the development to the local environment is mitigated appropriately.

A rainwater harvesting system is proposed to serve the welfare facilities within the administration building, reducing the demand for potable water use. The harvested water shall also be available for other uses within the process if required.

Foul water collected on site will be discharged to an existing foul sewer located outwith the emergency exit to the site. A pumping station will be required to convey flows to the existing foul sewer.

Dedicated drainage solutions have also been designed to accommodate a series of external reinforced concrete storage bunds and transformer installations.

Process water from within the building shall drain to a settling tank and shall be made available for re-use. The process drainage shall be a closed system and no discharge to external site drainage systems shall be permitted.

## **APPENDIX A**

PROPOSED SITE LAYOUT

## **APPENDIX B**

GREENFIELD RUN-OFF CALCULATIONS

## **APPENDIX C**

PROPOSED DRAINAGE DRAWINGS

## **APPENDIX D**

PROPOSED CATCHMENT PLAN

## **APPENDIX E**

MICRO DRAINAGE CALCULATIONS

## **APPENDIX F**

EXCEEDENCE MODELLING – OUT OF SEWER FLOODING EXTENTS

## **APPENDIX G**

MAINTENANCE SCHEDULES AND RESPONSIBILITIES

## APPENDICES





## APPENDIX A:

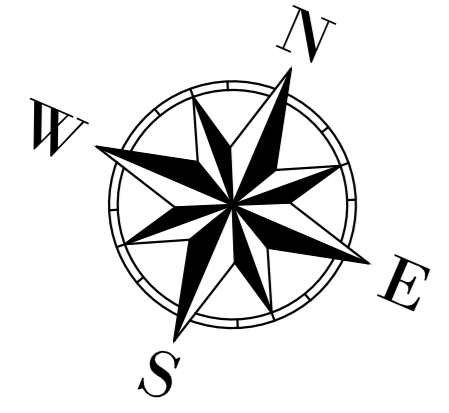

Rev.	Date	By	Check	Details	Appr.
P01	26/05/21	BMcC	AC	First Issue	PGK
P02	03/06/21	BMcC	AC	Road markings amended, Bund added.	PGK
P03	18/06/21	BMcC	AC	Proposed road construction amended.	PGK
P04	09/07/21	HJD	EF	Bund areas updated, contours revised to suit.	PGK
P05	21/12/21	HJD	AC	Layout updated, general revision.	PGK
P06	25/03/22	BMcC	AC	Layout updated, general revision.	PGK

- Legend**
- Proposed Asphalt Type A Road Construction
  - Proposed Asphalt Type B Road Construction
  - Proposed Car Park Construction
  - Proposed extent of Landscaping (Refer to Landscape Architect for further information)
  - Open Mosaic Habitat (Refer to Landscape Architect/Ecology drawings for further information)
  - Proposed Concrete Yard/Road Construction
  - Proposed Gravel Yard Construction
  - Proposed Asphalt Footpath Construction
  - Proposed Precast Concrete Half Battered Kerb
  - Proposed Drainage Kerb
  - Proposed Precast Concrete Bullnose Kerb
  - Proposed Precast Concrete Trief Kerb
  - Proposed Precast Concrete Edging Kerb
  - Proposed Fencing
  - Proposed Vehicle Barrier
  - Proposed Retaining Wall
  - Proposed Flexible Bollards
  - Proposed Pedestrian Rolling

Status	Date	By	Check	Drawing Status	Details	Appr.

**PRELIMINARY DRAWING**

Project Title:  
**TEES VALLEY EFW**

Drawing Title:  
**Proposed Layout  
General Arrangement**

Client/Architect:	H2I	Date:	May 21
Drawn by:	BMcC	Checked by:	AC
Checked by:	AC	Scale:	1:250
Approved by:	PGK	Sheet Size:	A0

Project Number:	Orig.	Zone	Level	Type	Disc.	Number	Revision
212018	DC	XX	XX	GA	C	202	P06

**Doran CONSULTING**  
DELIVERING ENGINEERING EXCELLENCE

Nowwood House  
88-100 Great Victoria Street,  
Belfast BT2 7BE  
T: 028 9033343  
F: 028 9020501  
E: mail@doran.co.uk  
W: www.doran.co.uk



## APPENDIX B:

Calculated by:

Site name:

Site location:

### Site Details

Latitude:

Longitude:

Reference:

Date:

This is an estimation of the greenfield runoff rates that are used to meet normal best practice criteria in line with Environment Agency guidance "Rainfall runoff management for developments", SC030219 (2013), the SuDS Manual C753 (Ciria, 2015) and the non-statutory standards for SuDS (Defra, 2015). This information on greenfield runoff rates may be the basis for setting consents for the drainage of surface water runoff from sites.

### Runoff estimation approach

### Site characteristics

Total site area (ha):

### Methodology

Q<sub>BAR</sub> estimation method:

SPR estimation method:

### Soil characteristics

	Default	Edited
SOIL type:	4	4
HOST class:	N/A	N/A
SPR/SPRHOST:	0.47	0.47

### Hydrological characteristics

	Default	Edited
SAAR (mm):	600	600
Hydrological region:	3	3
Growth curve factor 1 year:	0.86	0.86
Growth curve factor 30 years:	1.75	1.75
Growth curve factor 100 years:	2.08	2.08
Growth curve factor 200 years:	2.37	2.37

### Notes

#### (1) Is Q<sub>BAR</sub> < 2.0 l/s/ha?

When Q<sub>BAR</sub> is < 2.0 l/s/ha then limiting discharge rates are set at 2.0 l/s/ha.

#### (2) Are flow rates < 5.0 l/s?

Where flow rates are less than 5.0 l/s consent for discharge is usually set at 5.0 l/s if blockage from vegetation and other materials is possible. Lower consent flow rates may be set where the blockage risk is addressed by using appropriate drainage elements.

#### (3) Is SPR/SPRHOST ≤ 0.3?

Where groundwater levels are low enough the use of soakaways to avoid discharge offsite would normally be preferred for disposal of surface water runoff.

### Greenfield runoff rates

	Default	Edited
Q <sub>BAR</sub> (l/s):	36.7	36.7
1 in 1 year (l/s):	31.56	31.56
1 in 30 years (l/s):	64.23	64.23
1 in 100 year (l/s):	76.34	76.34
1 in 200 years (l/s):	86.99	86.99

This report was produced using the greenfield runoff tool developed by HR Wallingford and available at [www.uksuds.com](http://www.uksuds.com). The use of this tool is subject to the UK SuDS terms and conditions and licence agreement, which can both be found at [www.uksuds.com/terms-and-conditions.htm](http://www.uksuds.com/terms-and-conditions.htm). The outputs from this tool are estimates of greenfield runoff rates. The use of these results is the responsibility of the users of this tool. No liability will be accepted by HR Wallingford, the Environment Agency, CEH, Hydrosolutions or any other organisation for the use of this data in the design or operational characteristics of any drainage scheme.



## APPENDIX C:

Rev.	Date	By	Check	Details	Appr.
P01	08/06/21	OC	EF	First Issue	PGK
P02	18/06/21	OC	EF	Updated to reflect new site layout	PGK
P03	21/12/21	WMP	AC	Updated to reflect new site layout	PGK
P04	28/01/22	BMCC	AC	Updated to reflect new site layout	PGK
P05	25/03/22	BMCC	AC	Updated to reflect new site layout	PGK
P06	15/02/23	JPS	AC	Updated foul sewer arrangement	PGK

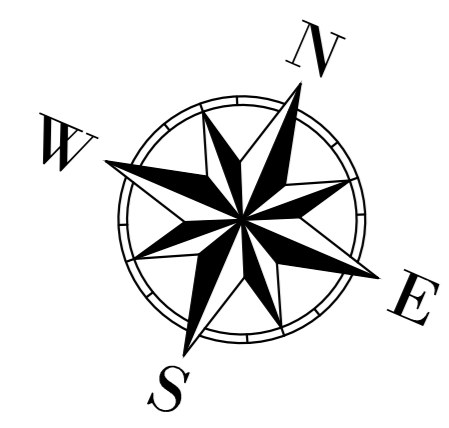

- Legend:**
- Proposed Foul Drainage
  - Proposed Surface Water Drainage
  - Proposed Rainwater Drainage
  - Proposed Land Drainage
  - Gravity Rainwater Connection
  - Siphonic Rainwater Connection
  - Heavy Duty D400 Load Class Road Gully
  - Proposed Drainage Channel
  - Proposed Drainage Kerb
  - Proposed Sump Outlet Unit
  - Proposed Pumping Main
  - Existing Foul Sewer

- Notes:**
- This drawing should be read in conjunction with all relevant Architectural and Engineering drawings.
  - All gullies to be trapped. Road gully grills to be heavy duty ductile iron (Load Class D400).
  - Refer to Architect's drawings for exact locations of all rainwater downpipes.
  - Refer to relevant Architect's and M&E Engineering drawings for exact locations of builder's upstands/ SVPs etc.
  - Contractor to ensure that all conditions of storm and foul drainage discharges are met. All discharge arrangements to be confirmed.
  - All pipework with diameter of 300mm or less to be uPVC pipes unless otherwise stated. All pipes with diameter greater than 300mm to be class II concrete or HDPE twin wall.
  - All pipes with cover exceeding 1.2m in trafficked areas and 0.9m in non-trafficked areas to have class S bedding. All pipes with cover less than 1.2m in trafficked areas and 0.9m in non-trafficked areas to have class Z bedding.
  - Contractor to confirm the location and level of any existing obstructions/structures etc., uncovered during the works.
  - Contractor to confirm the location and level of any existing sewers prior to the commencement of any works. Any discrepancies are to be notified to the engineer immediately.
  - Contractor to confirm the location of all existing services, buried and overhead, prior to the commencement of the works.
  - Drainage channels, indicated at door thresholds etc. to be Marshalls Birco 100 or approved similar. All required fixtures and fittings to be specified by drainage channel manufacturer. D400 gratings to be used in vehicle areas.
  - All drainage to be constructed in accordance with, 'WRC Sewers for Adoption'.
  - All setting out shall be in accordance with available Architecture drawings. This drawing shall not be used for setting out purposes.
  - All interceptors to be constructed in strict accordance with manufacturer's guidelines. All vents to be provided in agreed locations. All interceptors to be fitted with high level oil and silt alarms.
  - All works to comply with current British Standards, Codes of Practice, and Building Regulations. The Contractor shall verify all information on site and report any discrepancies immediately to the Architect/Engineer.

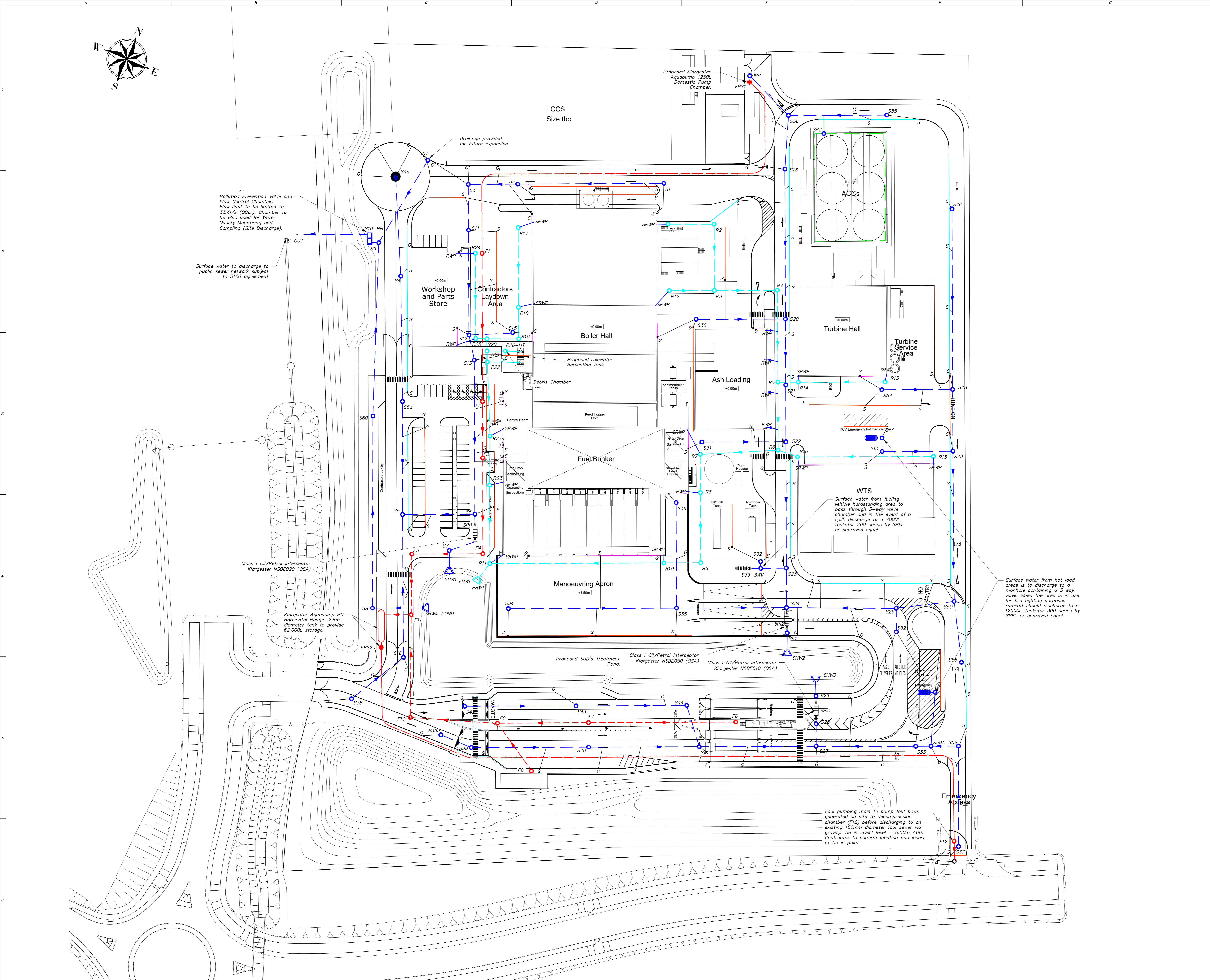

Pollution Prevention Valve and Flow Control Chamber. Flow limit to be limited to 3.34/s (0.8bar). Chamber to be also used for Water Quality Monitoring and Sampling (Site Discharge).

Surface water to discharge to public sewer network subject to S106 agreement

Class I Oil/Petrol Interceptor Klargester NSBE020 (OSA)

Klargester Aquapump PC Horizontal Range. 2.6m diameter tank to provide 62,000L storage.

Foul pumping main to pump foul flows generated on site to decompression chamber (F12) before discharging to an existing 150mm diameter foul sewer via gravity. Tie in invert level = 6.50m AOD. Contractor to confirm location and invert of tie in point.

Surface water from hot load areas is to discharge to a manhole containing a 3 way valve. When the area is in use for fire fighting purposes run-off should discharge to a 12000L Tankstor 300 series by SPEL or approved equal.

Status	Date	By	Check	Drawing Status	Details	Appr.

**PRELIMINARY DRAWING**

Project Title: **TEES VALLEY EFW**

Drawing Title: **Proposed Drainage Layout**

Client/Architect:	HZI	Date:	June '21
Drawn by:	OC	Checked by:	EF
Approved by:	PGK	Scale:	1:500
Project Number:	212018	Sheet Size:	A0

Project Number:	Zone:	Level:	Type:	Disc:	Number:	Revision:
212018	DC	XX	XX	GA	C	301 P06

86-100 Great Victoria Street, Belfast BT2 7BE  
 T: 028 90333443  
 F: 028 90250501  
 E: mail@doran.co.uk  
 W: www.doran.co.uk

Rev.	Date	By	Check	Details	Appr.
P01	08/06/21	OC	EF	First Issue	PGK
P02	21/06/21	OC	EF	Added typical flow control detail	PGK

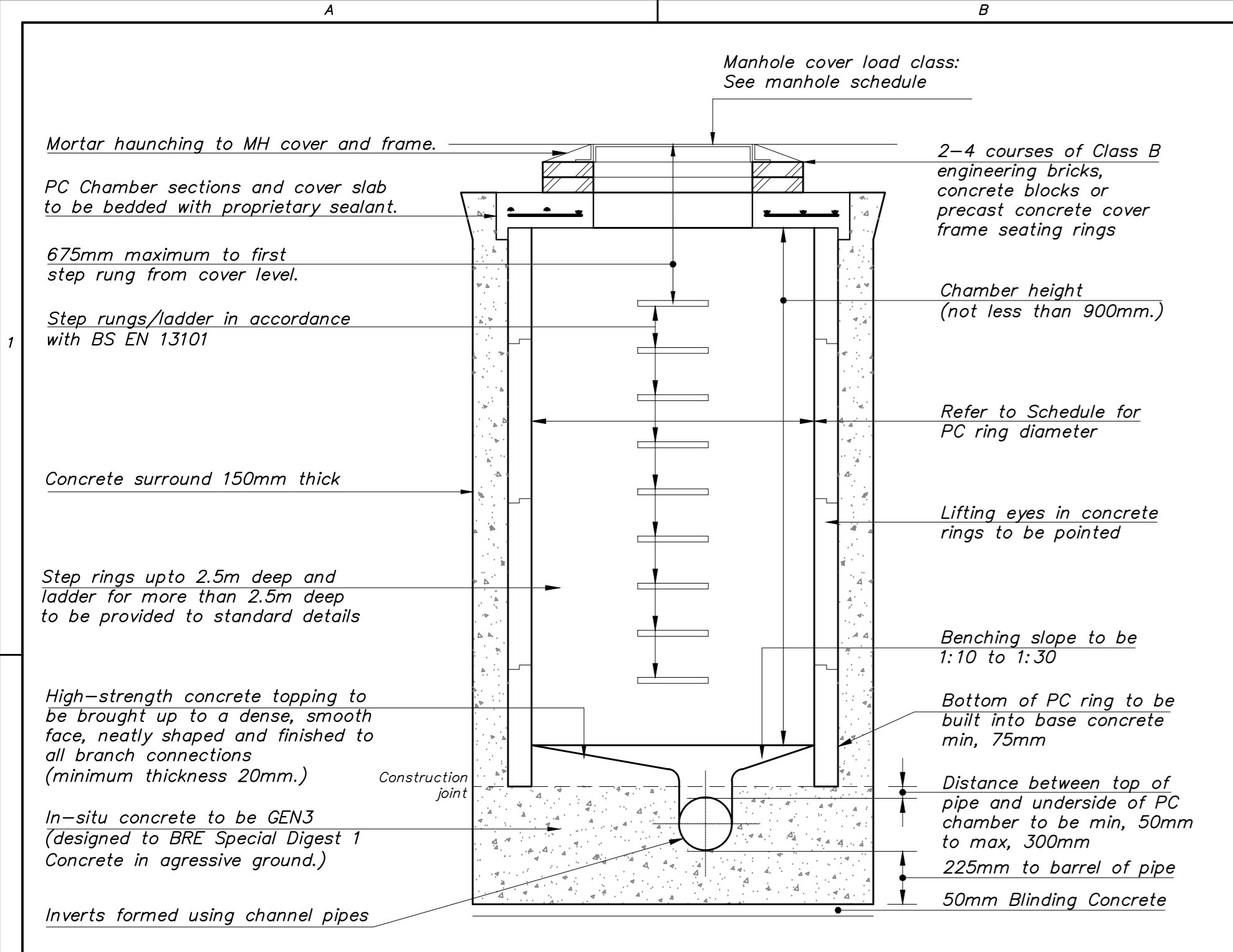

**Typical Manhole Detail - Type B**  
1:20  
Maximum depth from cover level to soffit of pipe 3.0m

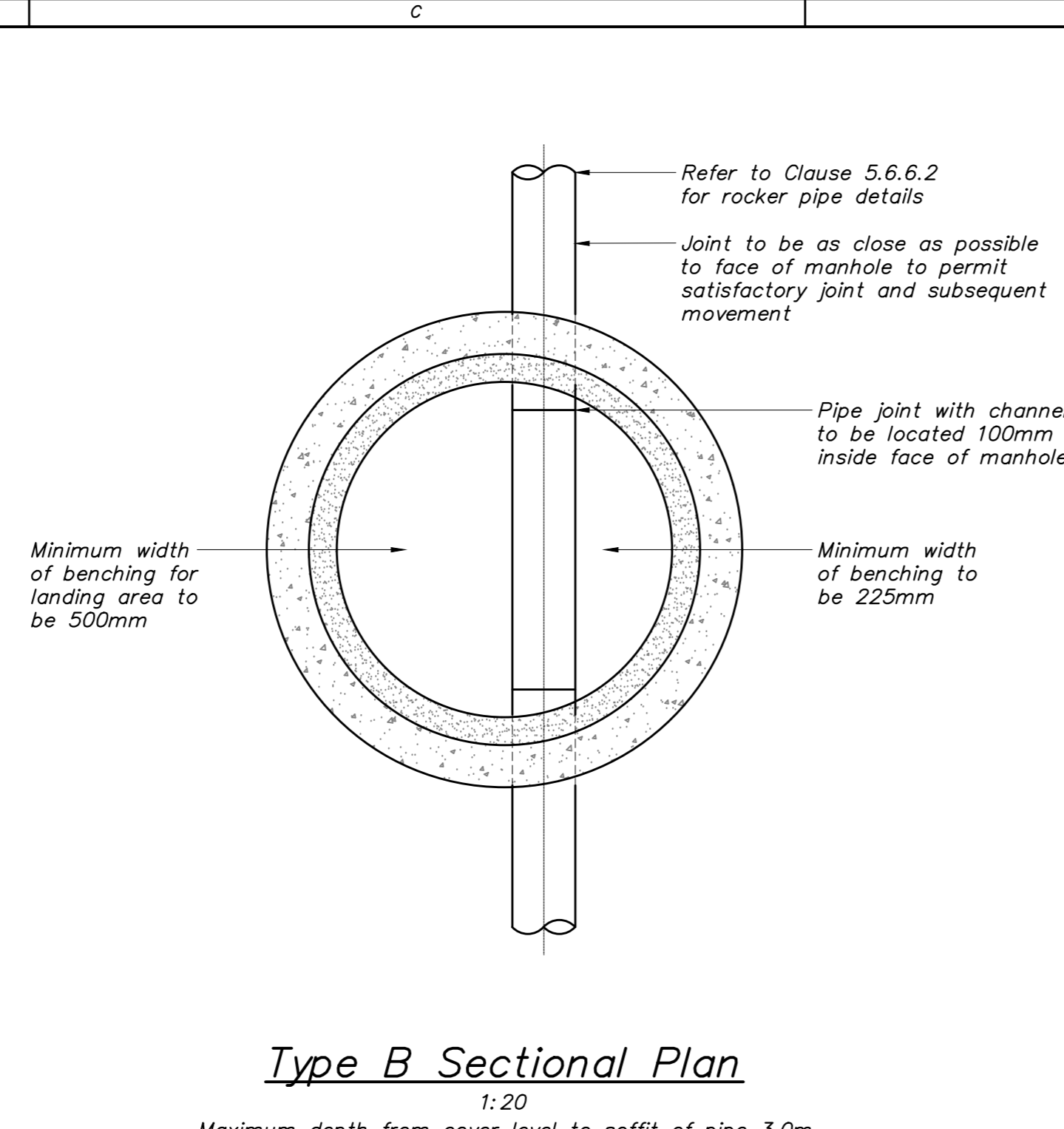

**Type B Sectional Plan**  
1:20  
Maximum depth from cover level to soffit of pipe 3.0m

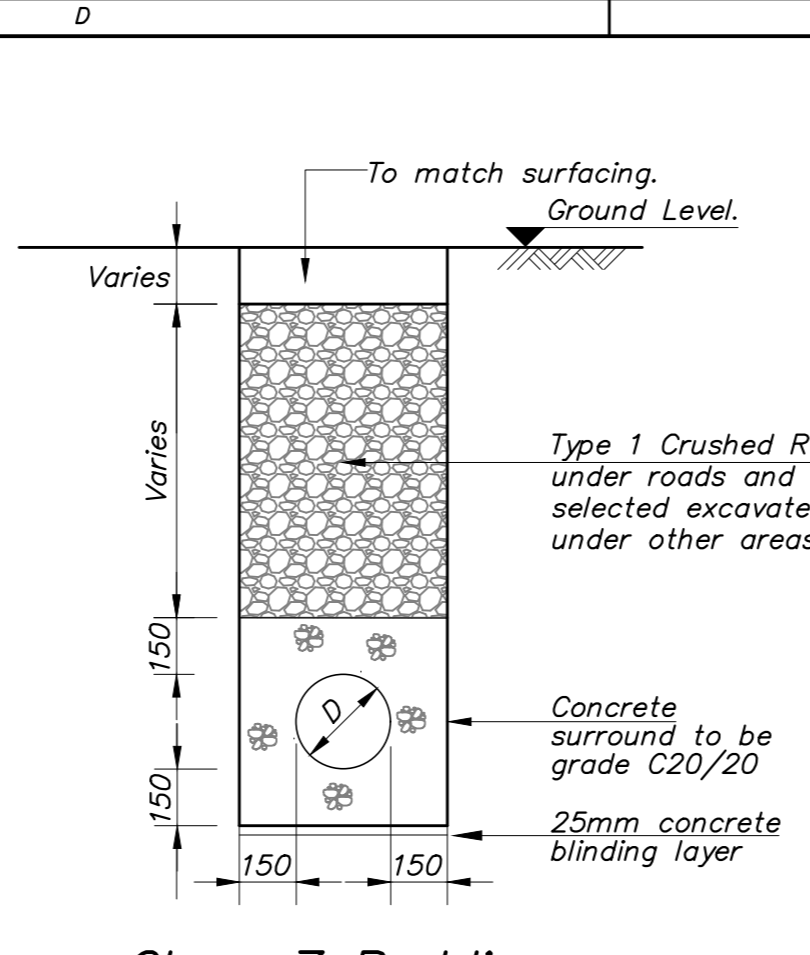

**Class Z Bedding**  
(Under Roads < 1.2m Cover)  
(Under Paths/Other areas < 0.9m Cover)  
1:20

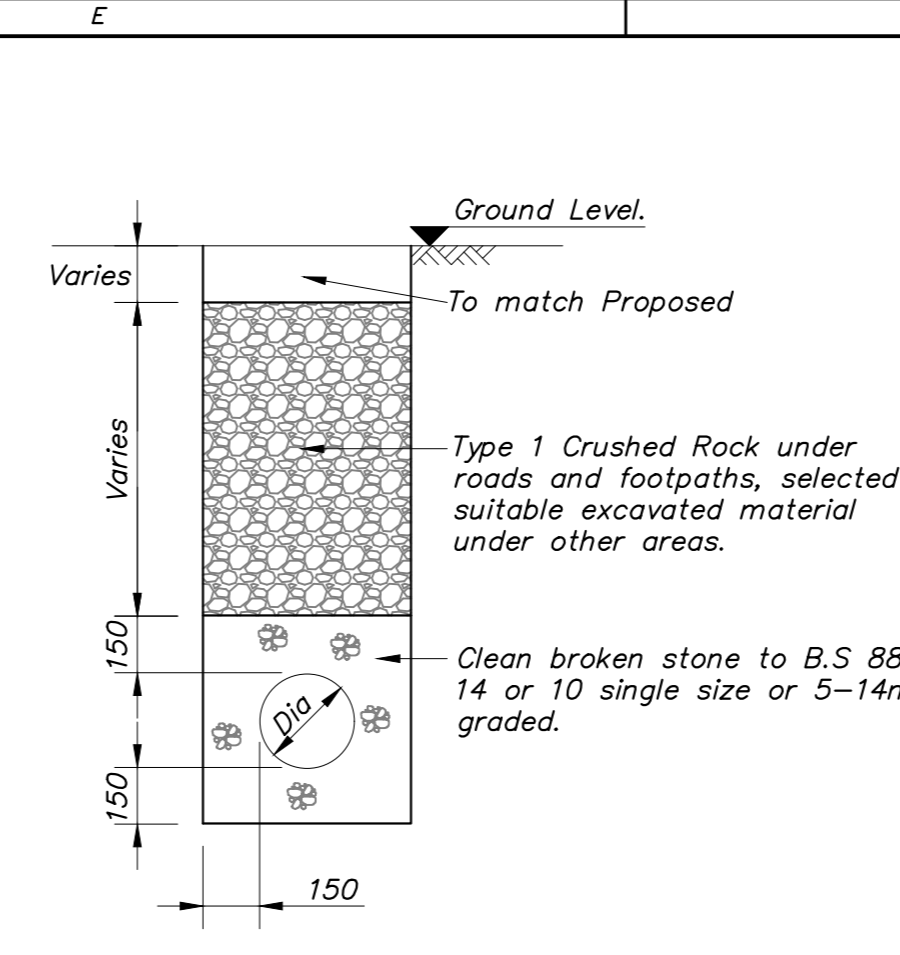

**Class S Bedding**  
Scale 1:20

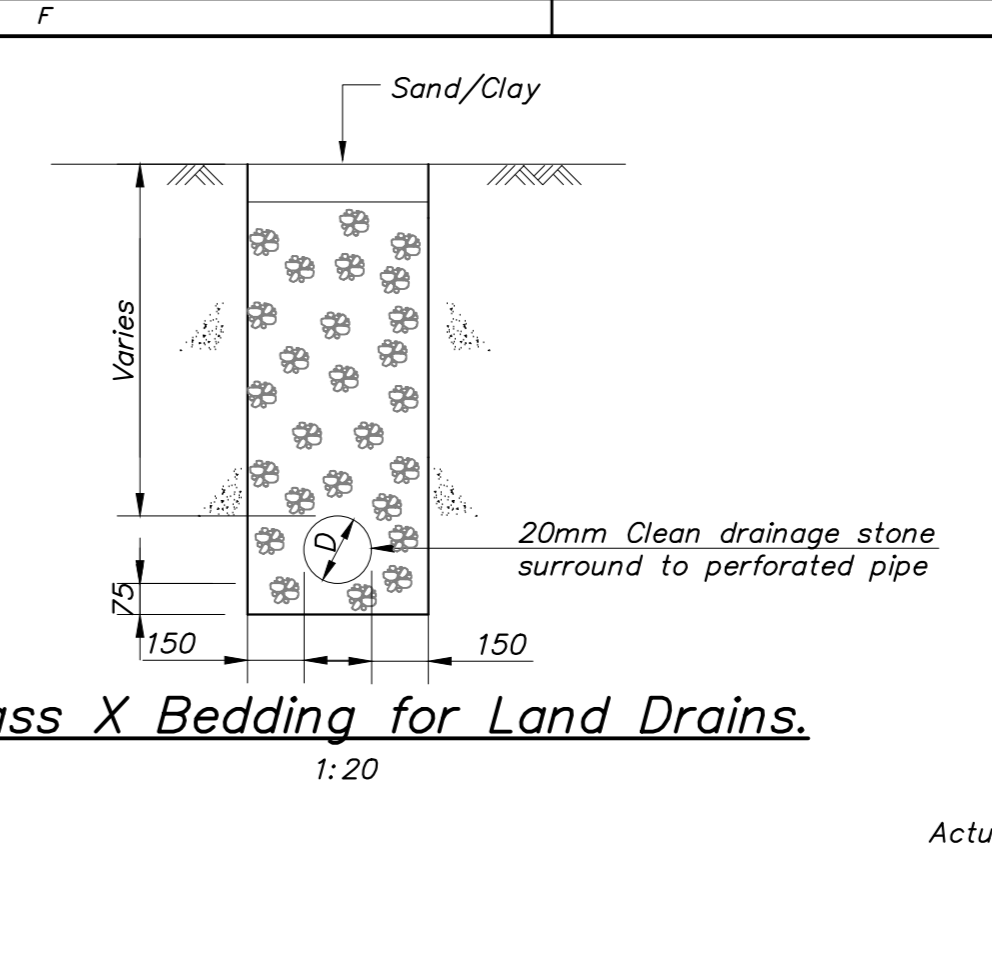

**Class X Bedding for Land Drains.**  
1:20

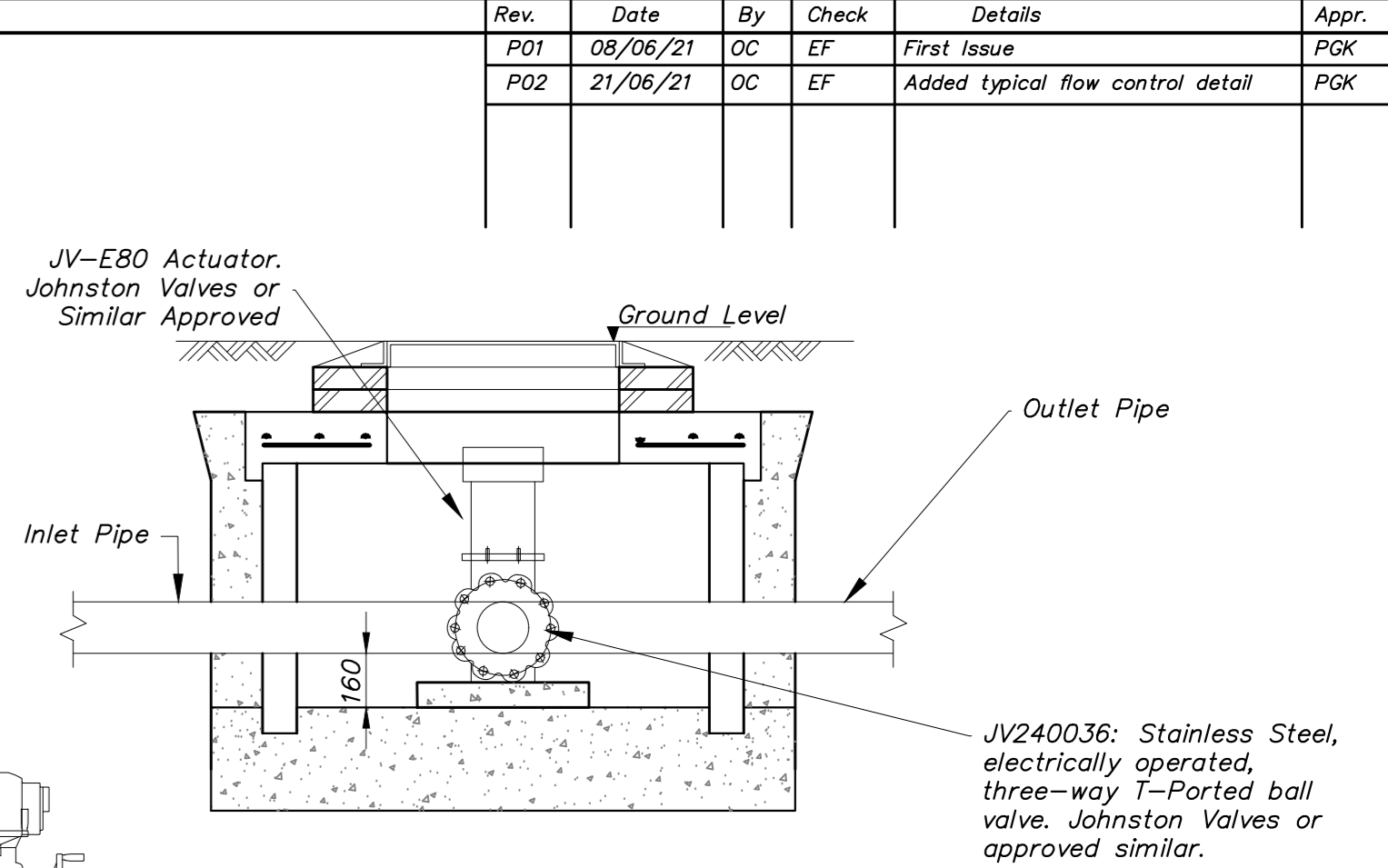

**3 Way Valve Chamber**  
1:20

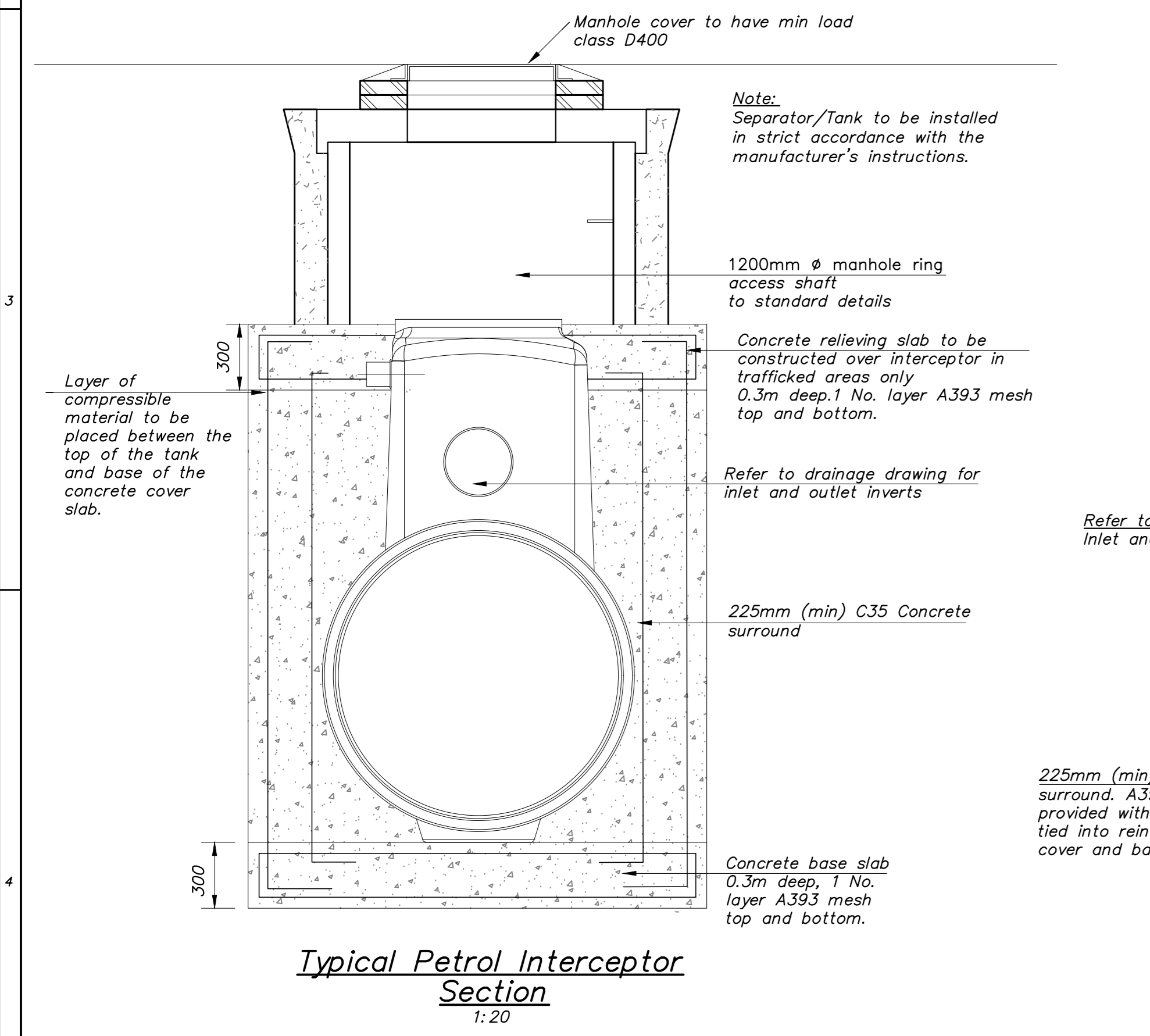

**Typical Petrol Interceptor Section**  
1:20

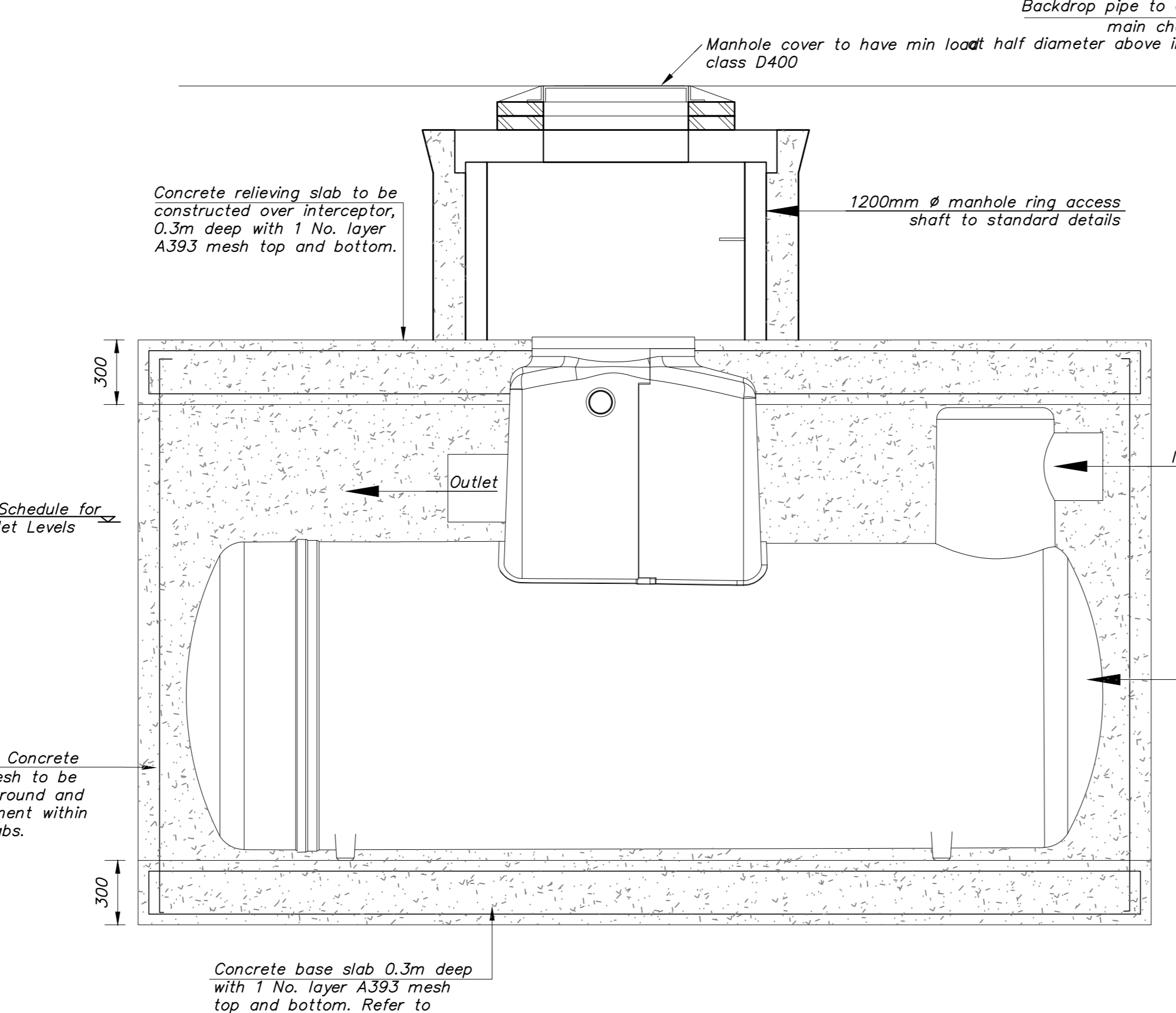

**Typical Petrol Interceptor Detail**  
1:20

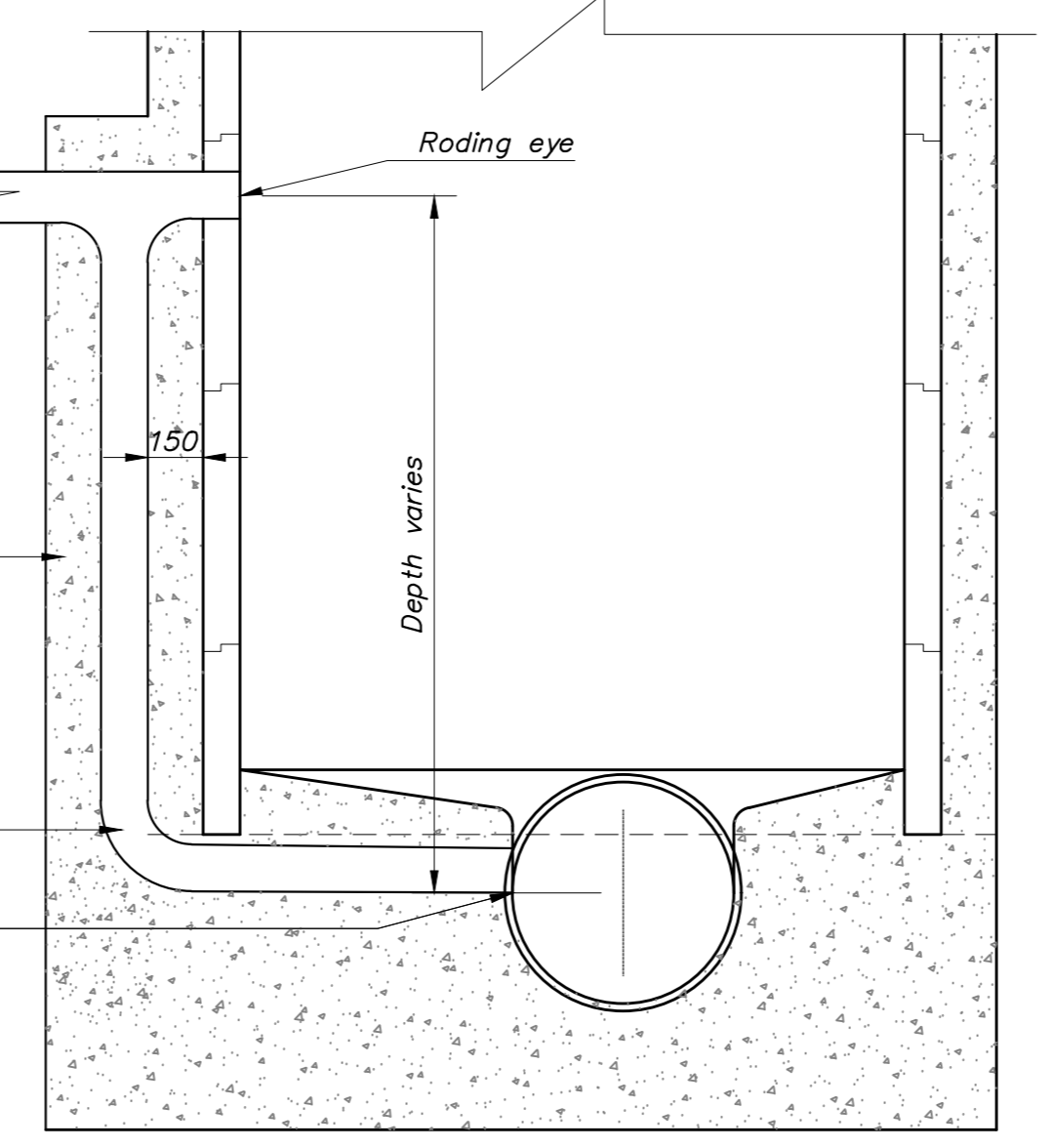

**Detail of External Backdrop Manhole.**  
NTS

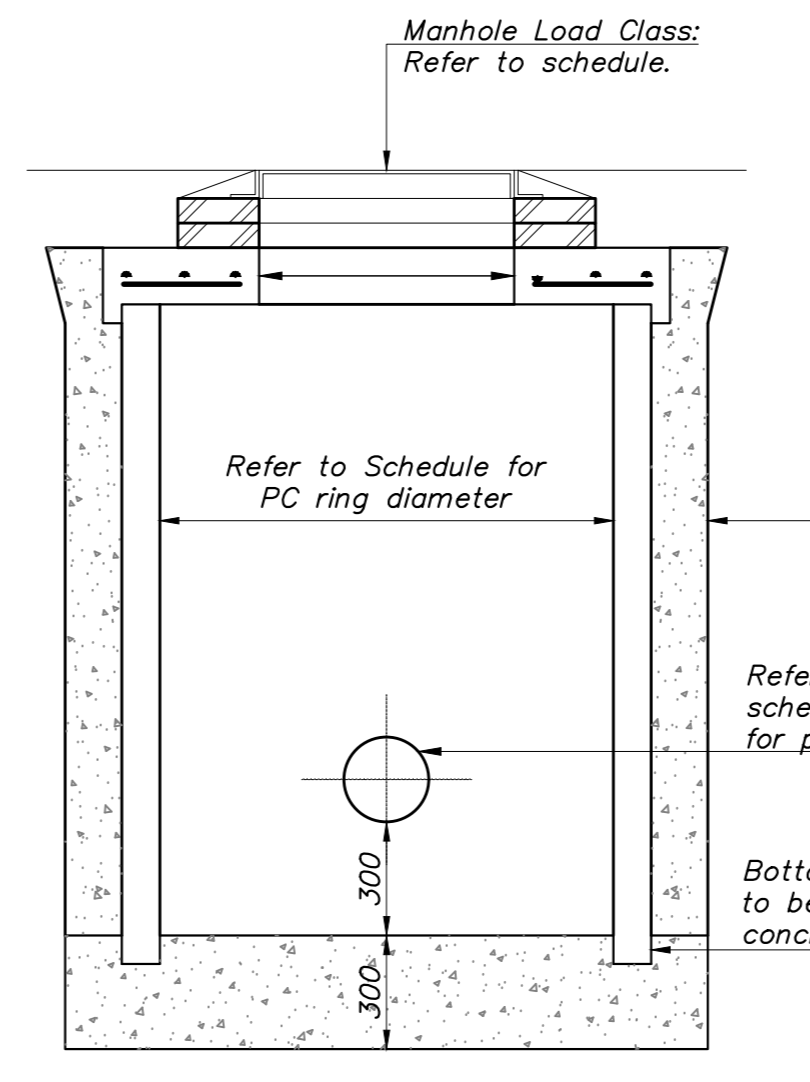

**Typical Silt Pit Detail**  
1:20

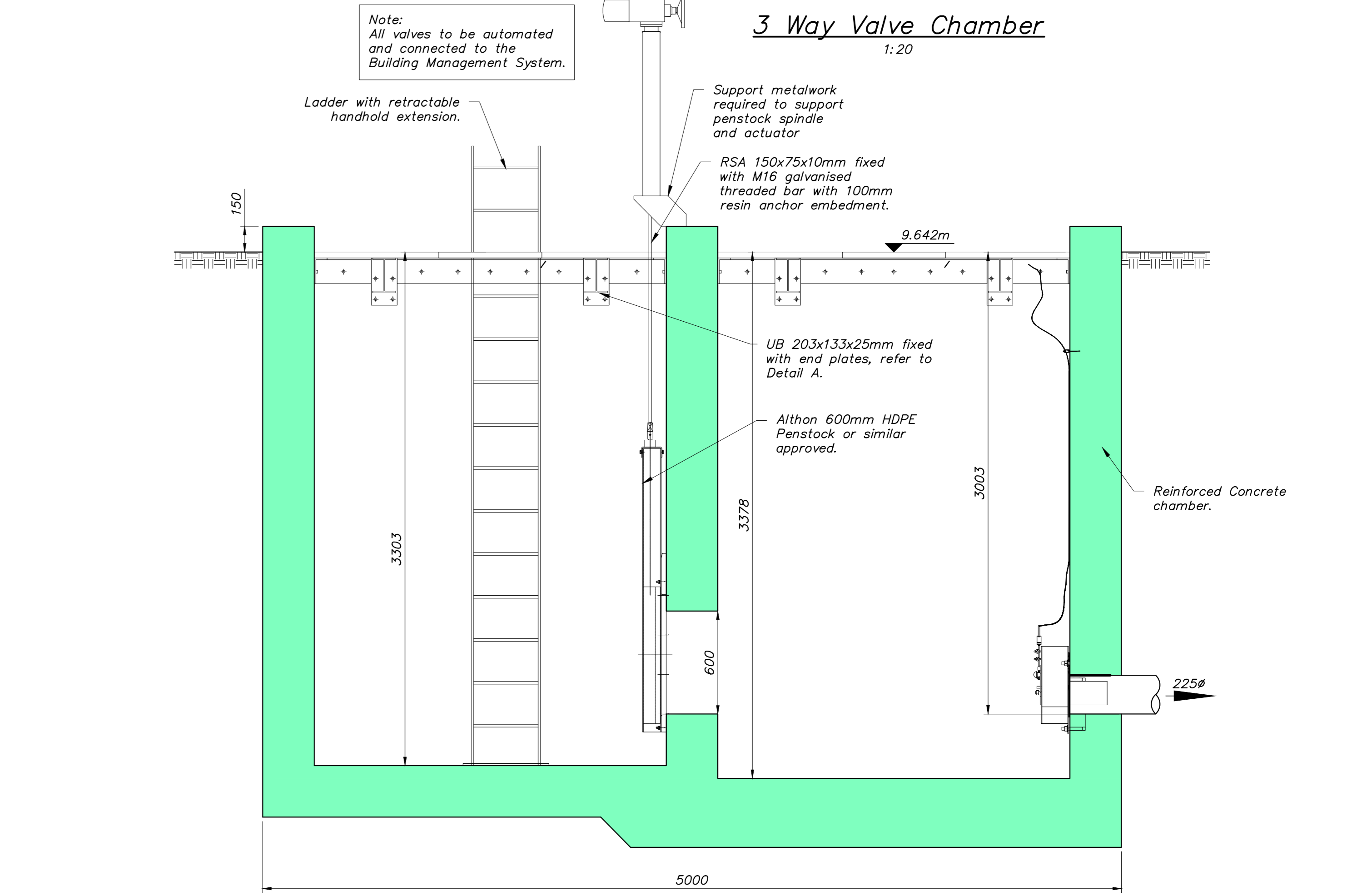

**Typical Valve/Flow Control Chamber Section 1-1**  
1:20

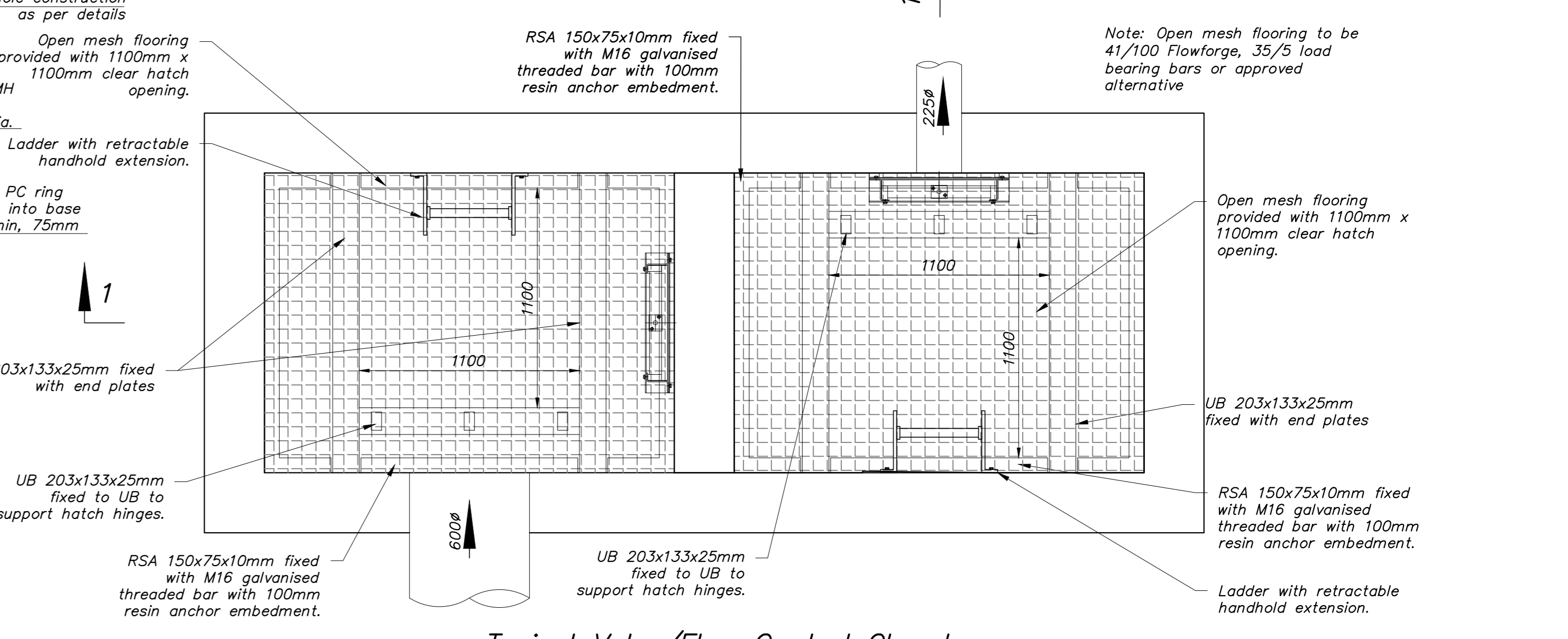

**Typical Valve/Flow Control Chamber Flooring Plan**  
1:20

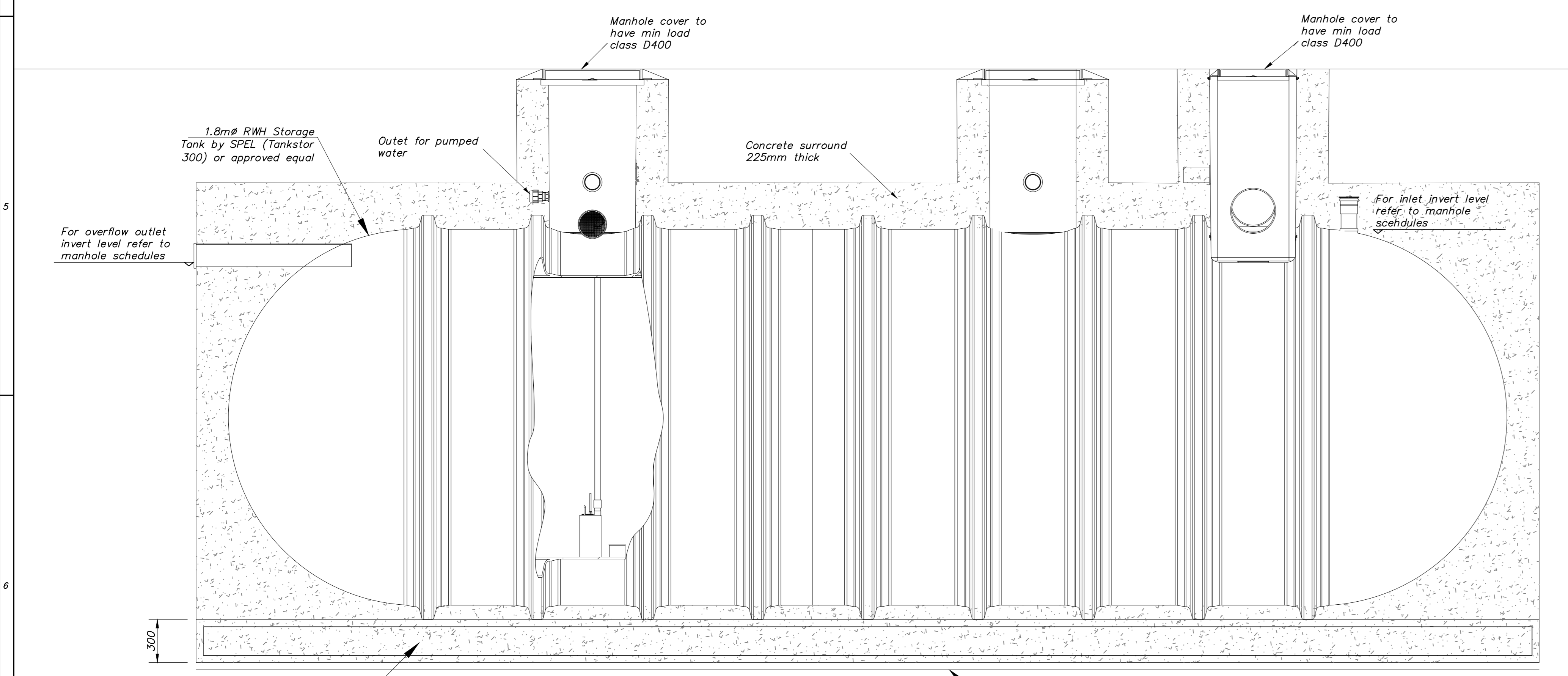

**30,000L Rain Water Harvesting Tank Detail**  
NTS

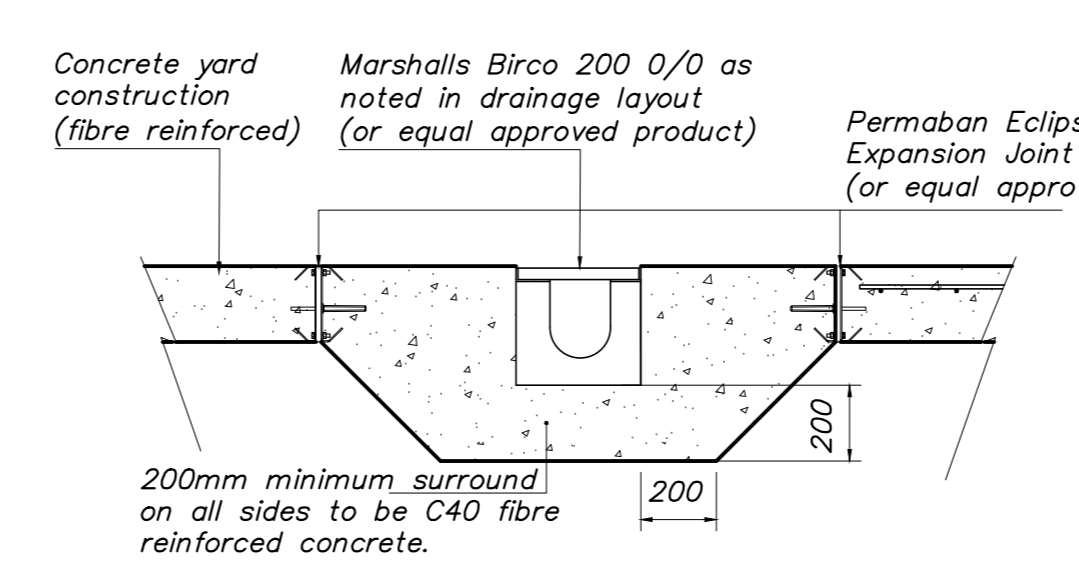

**Birco 200 Drainage Channel Installation Detail (Concrete Yard)**  
1:20

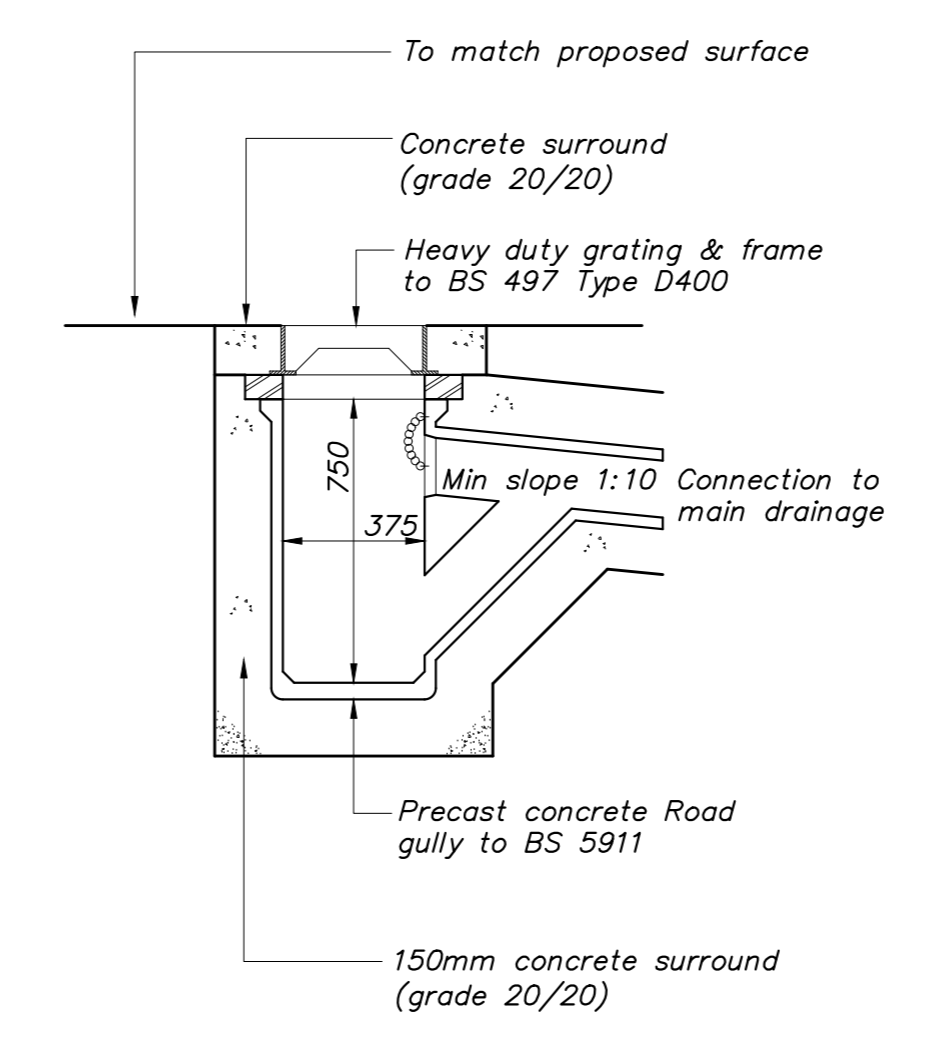

**Typical Detail Trapped Gully**  
1:20

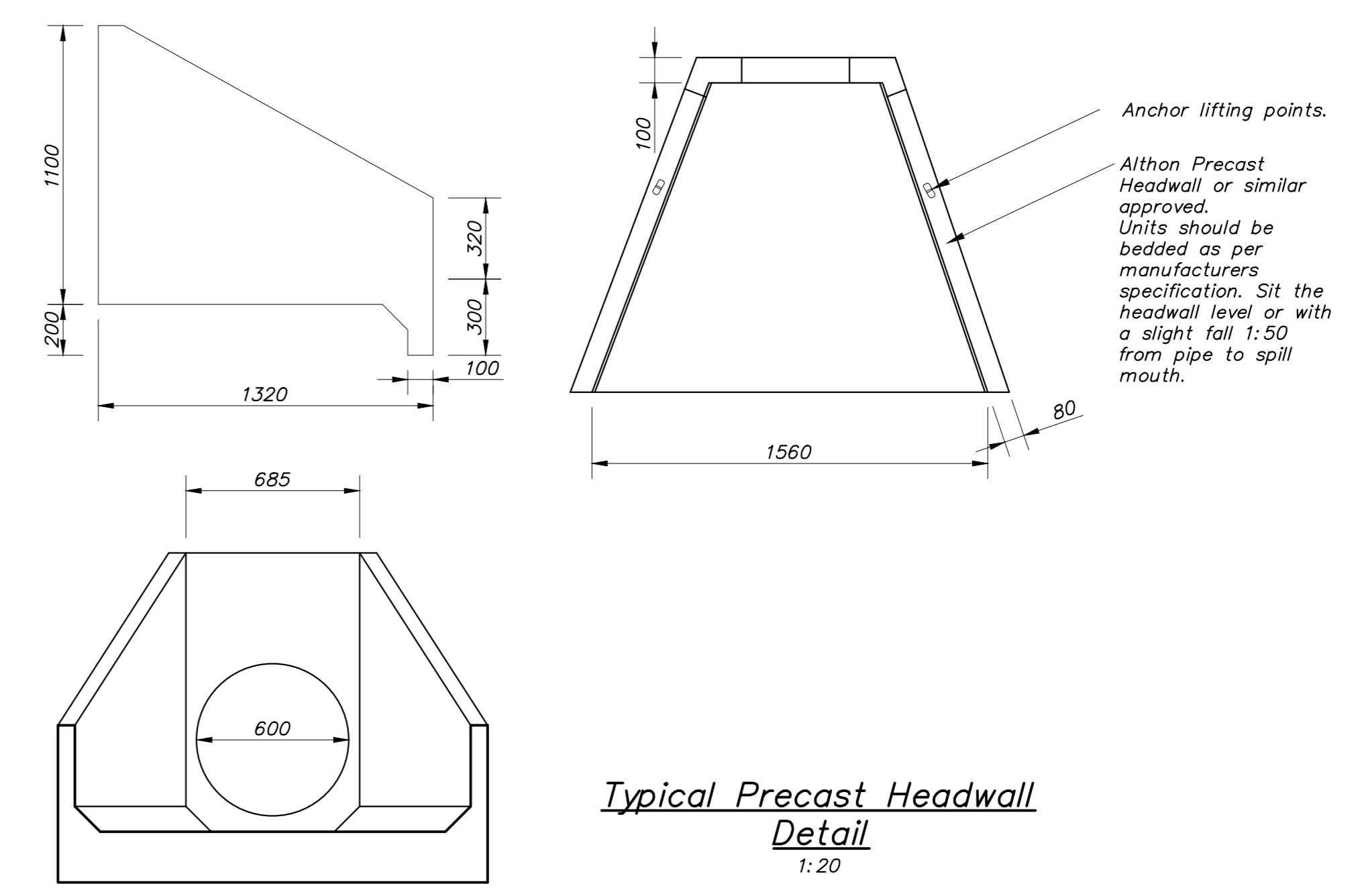

**Typical Precast Headwall Detail**  
1:20

Status	Date	By	Check	Drawing Status	Details	Appr.

**PRELIMINARY DRAWING**

Project Title: **TEES VALLEY EFW**

Drawing Title: **Proposed Drainage Proposed Drainage Details Sheet 1**

Client/Architect:	HZI	Date:	June '21
Drawn by:	OC	Scale:	As Shown
Checked by:	EF	Sheet Size:	A0
Approved by:	PGK	Drawing Number:	

Project Number:	Orig.	Zone	Level	Type	Disc	Number	Revision
212018	DC	XX	XX	GA	C	310	P02

Rev.	Date	By	Check	Details	Appr.
P01	08/06/21	OC	EF	First Issue	PGK
P02	15/02/23	JPS	AC	PIP details removed, pumping station detail added	PGK

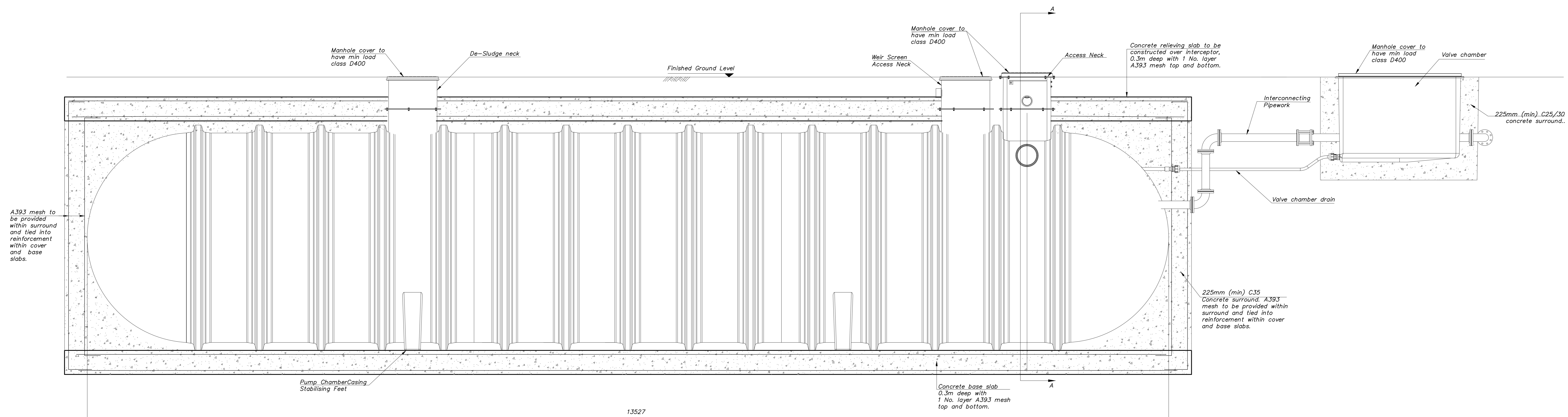

**Typical Horizontal Pumping Station**  
1:20

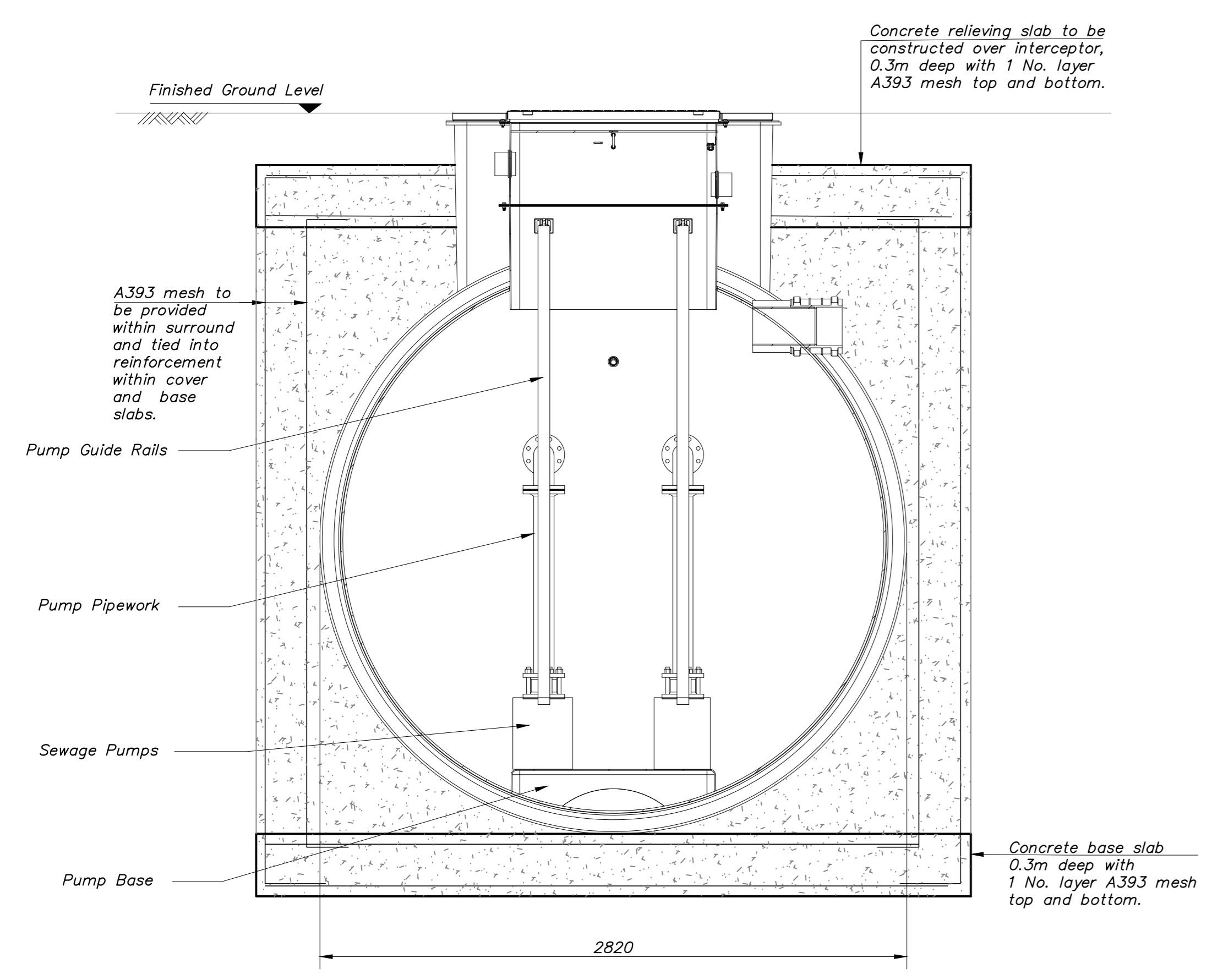

**Typical Horizontal Pumping Station Section A-A**  
1:20

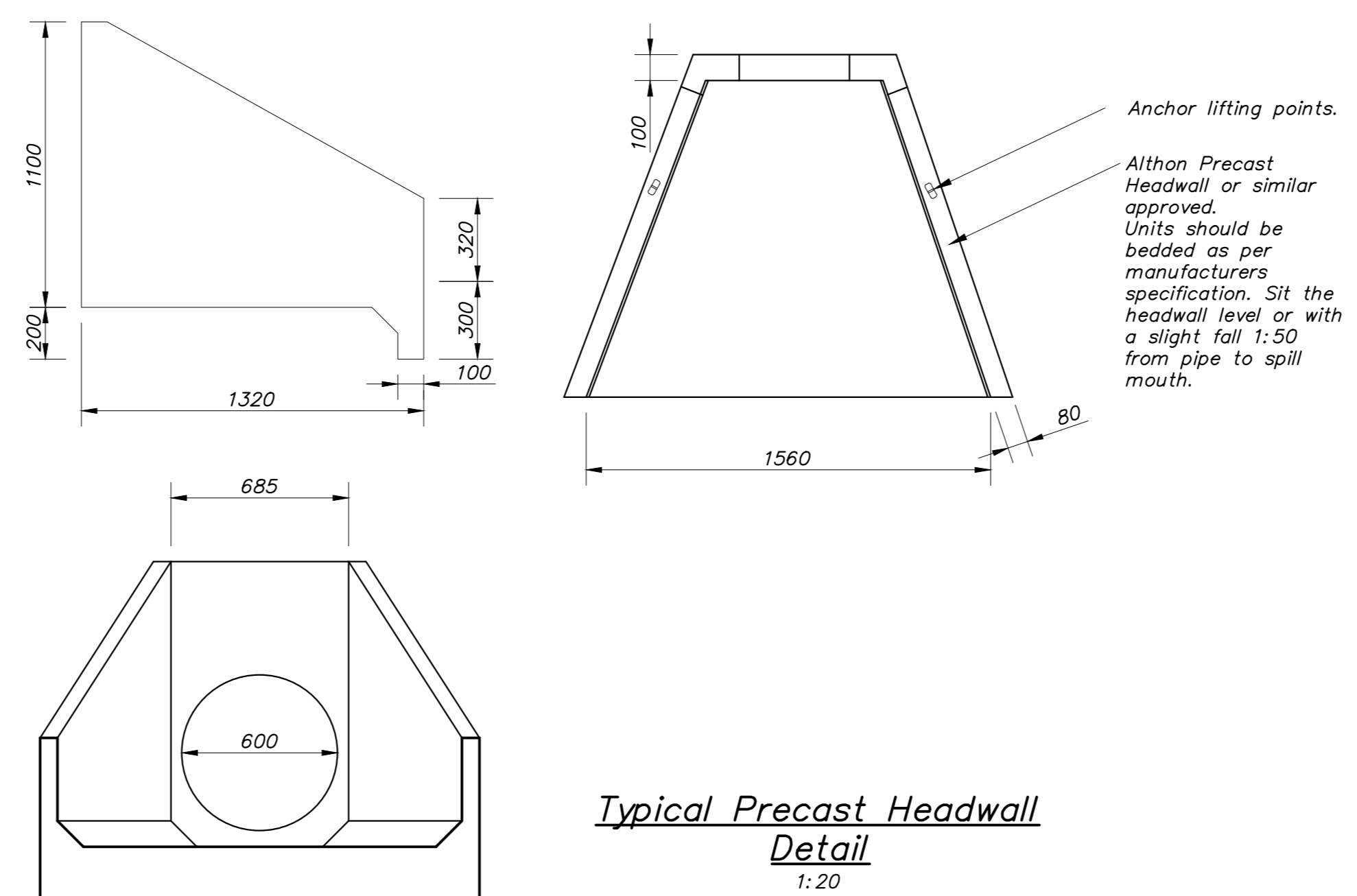

**Typical Precast Headwall Detail**  
1:20

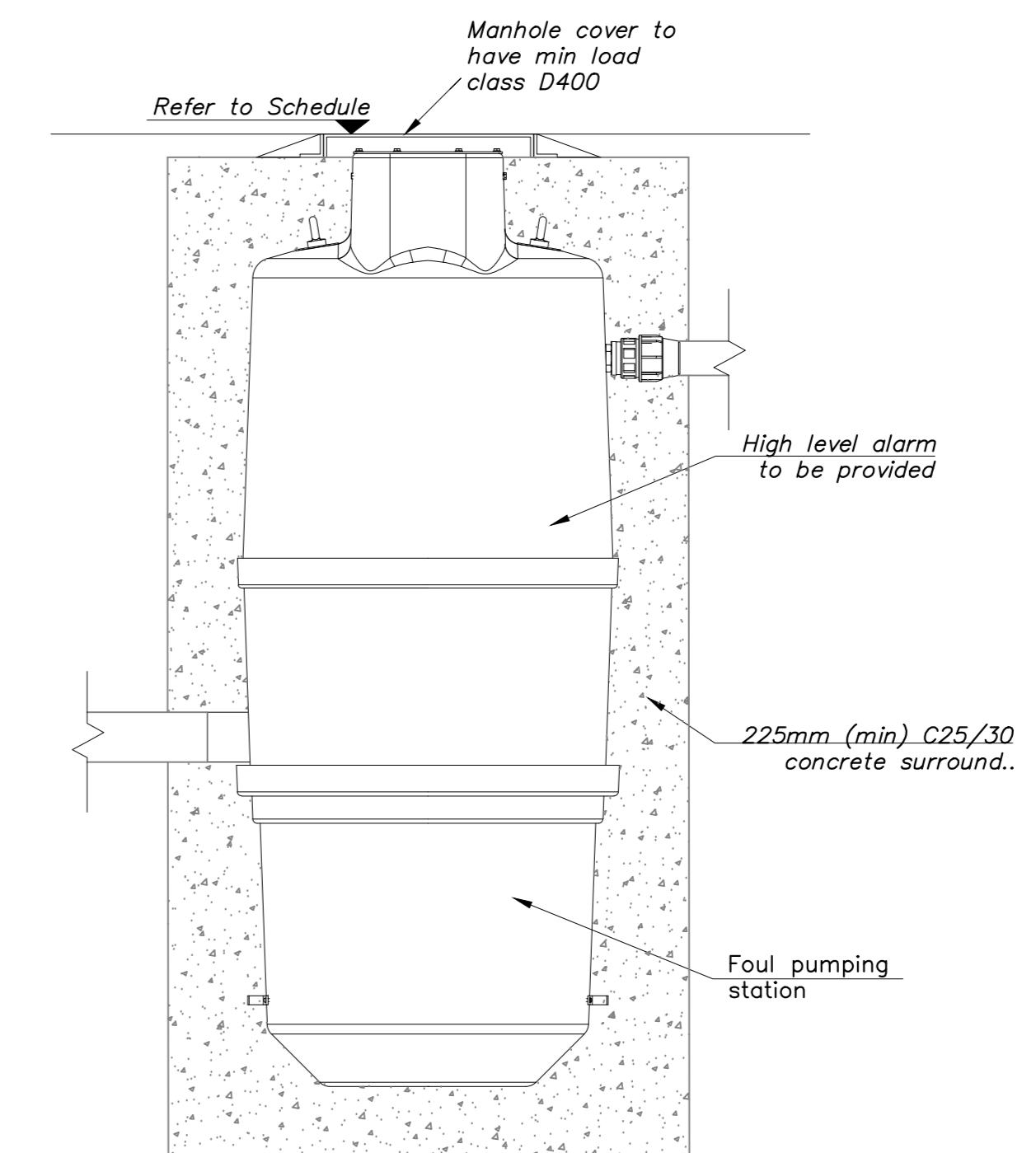

**Typical Foul Pumping Station Detail**  
1:20

Status	Date	By	Check	Drawing Status	Details	Appr.

**PRELIMINARY DRAWING**

Project Title:  
**TEES VALLEY EFW**

Drawing Title:  
**Proposed Drainage  
Proposed Drainage Details  
Sheet 2**

Client/Architect:	HZI	Date:	June '21
Drawn by:	OC	Checked by:	EF
Checked by:	EF	Scale:	As Shown
Approved by:	PGK	Sheet Size:	A0

Project Number	Orig	Zone	Level	Type	Disc	Number	Revision
212018	DC	XX	XX	GA	C	311	P02



Rev.	Date	By	Check	Details	Appr.
P01	22/06/21	DRM	AC	First Issue	PGK
P02	06/12/21	MKP	AC	Layout amended	PGK
P03	15/02/23	JPS	AC	Layout amended	PGK

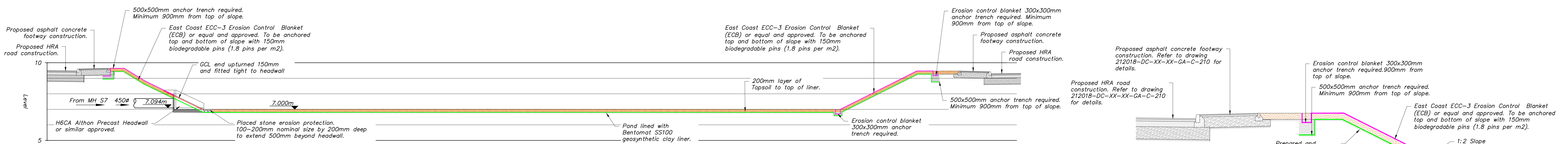
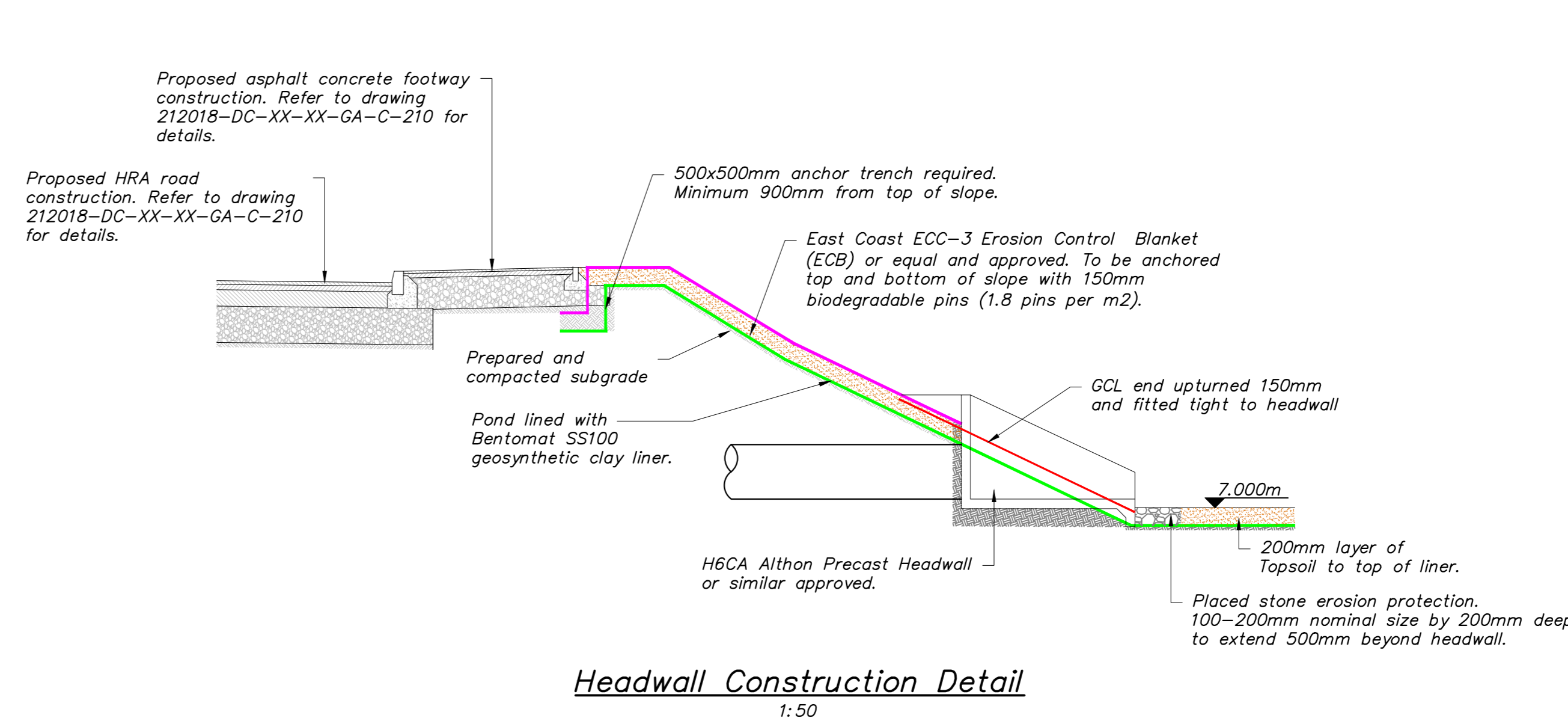
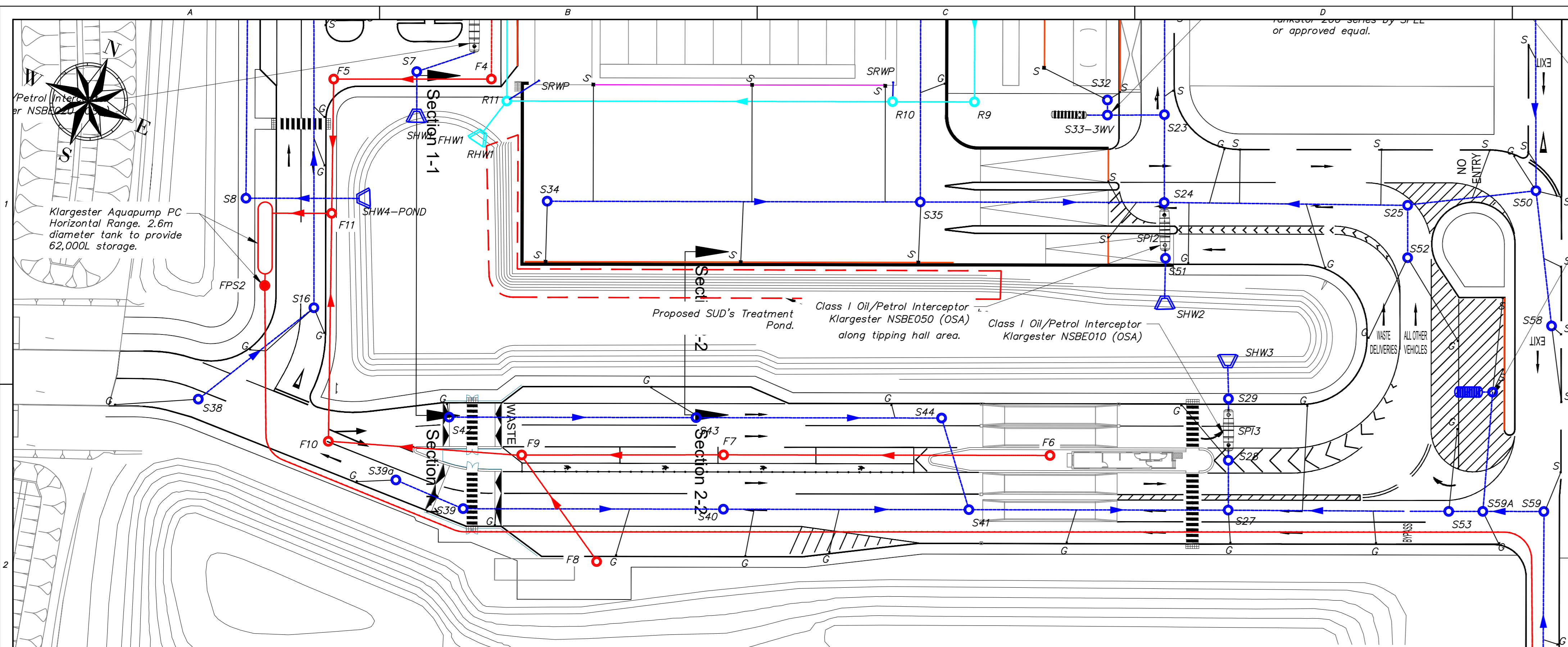

Chainage	0.00,000	05.000	10.000	15.000	20.000	25.000	30.000	35.000	40.000	45.000	50.000	55.000	60.000	65.500
Existing Levels	9.000	9.000	9.000	9.000	9.000	9.000	9.000	9.000	9.000	9.000	9.000	9.000	9.000	9.000
Proposed Levels	9.497	9.223	7.054	7.000	7.000	7.000	7.000	7.000	7.000	7.000	9.436	9.436	9.436	9.317

Section 1-1 Scale 1:100  
Scale: H 1:100, V 1:100, Datum: 5.000

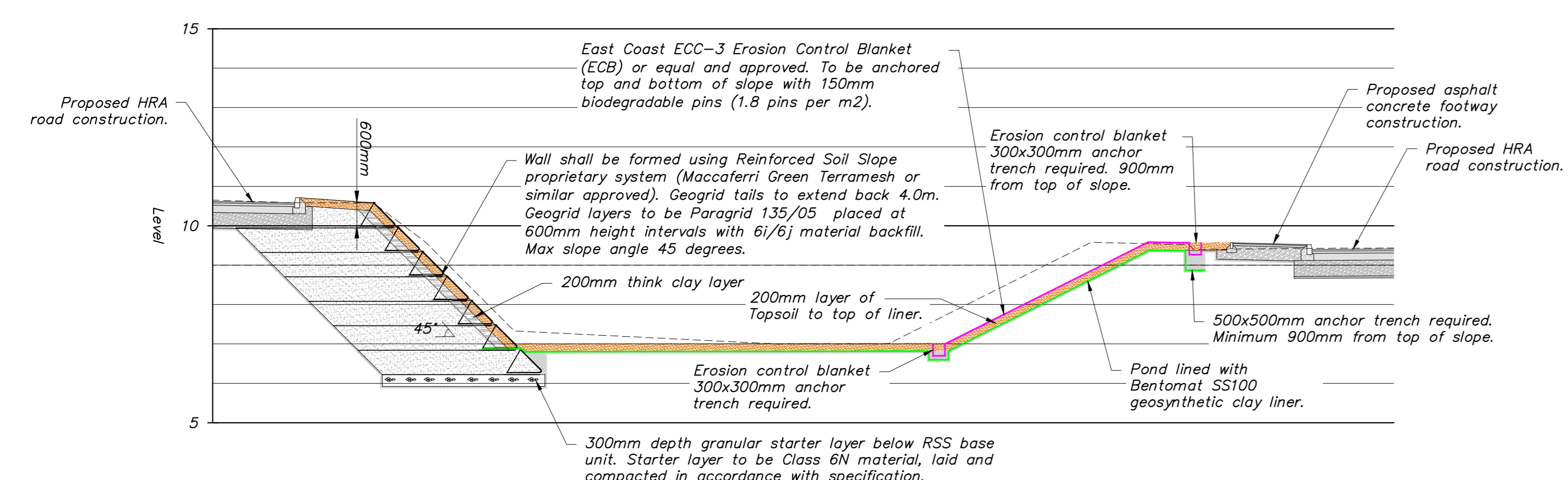

Chainage	10.051	05.000	10.000	15.000	20.000	25.000	30.000
Existing Levels	9.000	9.000	9.000	9.000	9.000	9.000	9.000
Proposed Levels	10.651	9.889	7.214	7.000	8.423	9.397	9.436

Section 2-2 Scale 1:100  
Scale: H 1:100, V 1:100, Datum: 5.000

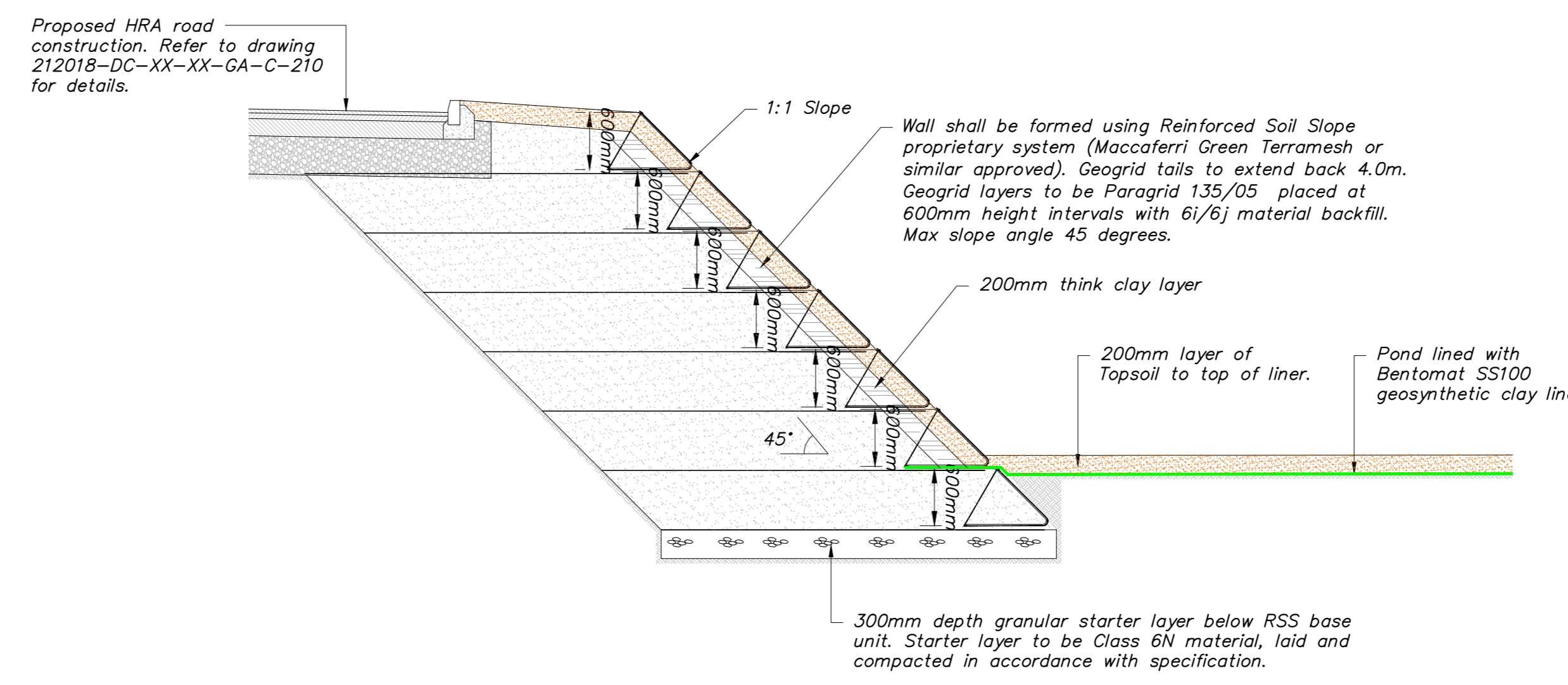

**Legend:**  
 - East Coast ECC-3 Erosion Control Blanket (ECB) or equal and approved  
 - Bentotex 50 Geosynthetic Clay Liner (GCL)

Status	Date	By	Check	Drawing Status	Details	Appr.

**PRELIMINARY DRAWING**

Project Title:  
**TEES VALLEY EFW**

Drawing Title:  
**Proposed Pond Sections**

Client/Architect:	HITACHI ZOSEN INOVA	Date:	June 2021
Drawn by:	DRM	Checked by:	AC
Scale:	1:500	Sheet Size:	A0
Approved by:	PGK	Drawing Number:	
Project Number:	212018-DC-XX-XX-GA-C-312-P03	Zone:	DC
Level:	XX	Type:	GA
Disc Number:	C	Revision:	P03

Rev.	Date	By	Check	Details	Appr.
P01	08/06/21	OC	EF	First Issue	PGK
P02	21/06/21	OC	EF	Updated to reflect new site layout	PGK

SURFACE WATER MANHOLE SCHEDULE

Manhole Number	Cover Level	Connections	Pipe			Manhole Size	Types		
			Code	Inverts	Diams		Manhole	Cover	
SHW1	8.687		1	1.006	7.094	450	N/A	Headwall	
	Coordinates								N/A
	E. 454383.474 N. 521261.269								
SPI1	9.434		1	1.004	7.131	450	1350	Type B	
	Coordinates								D400
	E. 454388.836 N. 521275.437								
S1	9.478		1	3.000	8.428	150	1200	Type B	
	Coordinates								D400
	E. 454401.899 N. 521440.053								
S2	9.488		1	3.000	8.068	150	1200	Type B	
	Coordinates								D400
	E. 454352.411 N. 521418.563								
SHW2	8.271		1	12.009	7.052	525	N/A	Headwall	
	Coordinates								N/A
	E. 454523.252 N. 521284.759								
SPI2	9.984		1	12.007	7.077	525	1500	Type B	
	Coordinates								D400
	E. 454518.259 N. 521296.222								
S3	9.402		1	3.002	7.801	300	1200	Type B	
	Coordinates								D400
	E. 454328.799 N. 521408.193								
SHW3	8.316		1	24.007	7.244	300	N/A	Headwall	
	Coordinates								N/A
	E. 454538.789 N. 521278.064								
SPI3	9.566		1	24.005	7.283	300	1200	Type B	
	Coordinates								D400
	E. 454543.819 N. 521267.333								
S4	9.555		1	1.000	8.297	150	1200	Type B	
	Coordinates								D400
	E. 454318.248 N. 521362.956								
S5	9.420		1	1.001	8.222	225	1200	Type B	
	Coordinates								D400
	E. 454357.318 N. 521273.984								
S6	9.423		1	3.005	7.352	300	1350	Type B	
	Coordinates								D400
	E. 454384.341 N. 521285.718								
S7	9.505		1	1.005	7.109	450	1350	Type B	
	Coordinates								D400
	E. 454380.560 N. 521267.984								
S8	9.471		1	1.008	6.958	600	1500	Type B	
	Coordinates								D400
	E. 454361.090 N. 521234.092								
S9	9.746		1	1.010	6.659	300	1500	Type B	
	Coordinates								D400
	E. 454304.636 N. 521371.973								
S11	9.463		1	3.003	7.739	300	1200	Type B	
	Coordinates								D400
	E. 454336.268 N. 521391.102								
S12	9.472		1	4.000	8.237	150	1200	Type B	
	Coordinates								D400
	E. 454353.268 N. 521351.836								
S13	9.500		1	3.004	7.562	300	1200	Type B	
	Coordinates								D400
	E. 454359.337 N. 521343.330								

SURFACE WATER MANHOLE SCHEDULE

Manhole Number	Cover Level	Connections	Pipe			Manhole Size	Types		
			Code	Inverts	Diams		Manhole	Cover	
S15	9.406		1	4.000	8.356	150	1200	Type B	
	Coordinates								D400
	E. 454369.293 N. 521359.919								
S16	9.166		1	2.000	7.816	150	1200	Type B	
	Coordinates								D400
	E. 454380.612 N. 521220.617								
S18	9.385		1	12.001	8.043	150	1200	Type B	
	Coordinates								D400
	E. 454444.929 N. 521464.866								
S20	9.359		1	12.002	7.964	225	1200	Type B	
	Coordinates								D400
	E. 454469.267 N. 521408.810								
S21	9.334		1	12.003	7.635	300	1200	Type B	
	Coordinates								D400
	E. 454479.966 N. 521384.148								
S22	9.326		1	12.004	7.589	300	1350	Type B	
	Coordinates								D400
	E. 454489.179 N. 521382.923								
S23	9.336		1	12.005	7.514	375	1350	Type B	
	Coordinates								D400
	E. 454509.682 N. 521315.689								
S24	9.653		1	19.004	7.162	450	1500	Type B	
	Coordinates								D400
	E. 454516.108 N. 521300.884								
S25	9.627		1	23.000	7.581	150	1350	Type B	
	Coordinates								D400
	E. 454557.333 N. 521318.285								
S27	9.529		1	24.003	7.489	300	1200	Type B	
	Coordinates								D400
	E. 454549.533 N. 521253.730								
S28	9.579		1	24.004	7.302	300	1200	Type B	
	Coordinates								D400
	E. 454545.869 N. 521282.147								
S29	9.714		1	24.006	7.264	300	1200	Type B	
	Coordinates								D400
	E. 454541.368 N. 521272.518								
S30	9.503		1	14.000	8.453	150	1200	Type B	
	Coordinates								D400
	E. 454435.849 N. 521394.306								
S31	9.485		1	15.000	8.435	150	1200	Type B	
	Coordinates								D400
	E. 454457.752 N. 521349.286								
S32	9.562		1	16.000	8.737	225	1200	Type B	
	Coordinates								D400
	E. 454499.003 N. 521313.966								
S34	10.727		1	17.000	9.077	450	1350	Type B	
	Coordinates								D400
	E. 454412.078 N. 521255.728								
S35	10.757		1	18.000	8.163	225	1350	Type B	
	Coordinates								D400
	E. 454474.967 N. 521283.026								
S36	11.000		1	18.000	9.575	225	1200	Type B	
	Coordinates								D400
	E. 454457.843 N. 521322.477								

SURFACE WATER MANHOLE SCHEDULE

Manhole Number	Cover Level	Connections	Pipe			Manhole Size	Types		
			Code	Inverts	Diams		Manhole	Cover	
S37	9.350		1	26.000	8.122	150	1200	Type B	
	Coordinates								D400
	E. 454603.545 N. 521232.398								
S38	9.070		1	2.000	7.997	150	1200	Type B	
	Coordinates								D400
	E. 454367.833 N. 521196.720								
S39	9.335		1	24.001	8.217	150	1200	Type B	
	Coordinates								D400
	E. 454420.516 N. 521187.735								
S40	9.380		1	24.001	7.908	300	1200	Type B	
	Coordinates								D400
	E. 454464.404 N. 521216.784								
S41	9.493		1	24.003	7.757	300	1200	Type B	
	Coordinates								D400
	E. 454505.782 N. 521234.748								
S42	9.347		1	25.000	8.147	300	1200	Type B	
	Coordinates								D400
	E. 454411.417 N. 521212.134								
S43	9.417		1	25.001	7.996	300	1200	Type B	
	Coordinates								D400
	E. 454453.069 N. 521230.213								
S44	9.502		1	25.001	7.845	300	1200	Type B	
	Coordinates								D400
	E. 454494.457 N. 521248.177								
S46	9.178		1	19.000	8.053	225	1200	Type B	
	Coordinates								D400
	E. 454513.892 N. 521478.884								
S48	9.162		1	19.001	8.168	225	1200	Type B	
	Coordinates								D400
	E. 454543.212 N. 521409.338								
S49	9.180		1	19.002	7.421	450	1350	Type B	
	Coordinates								D400
	E. 454553.250 N. 521386.212								
S50	9.430		1	22.000	8.106	150	1350	Type B	
	Coordinates								D400
	E. 454577.865 N. 521330.177								
S51	9.837		1	12.008	7.299	450	1500	Type B	
	Coordinates								D400
	E. 454520.409 N. 521291.560								
S52	9.782		1	23.000	8.732	150	1200	Type B	
	Coordinates								D400
	E. 454561.165 N. 521309.463								
S53	9.401		1	26.000	7.849	150	1200	Type B	
	Coordinates								D400
	E. 454586.796 N. 521269.739								
S54	9.378		1	20.000	8.414	150	1200	Type B	
	Coordinates								D400
	E. 454516.736 N. 521387.845								
S55	9.506		1	12.000	8.456	150	1200	Type B	
	Coordinates								D400
	E. 454474.361 N. 521501.513								
S56	9.530		1	13.000	8.189	150	1200	Type B	
	Coordinates								D400
	E. 454437.630 N. 521485.569								

SURFACE WATER MANHOLE SCHEDULE

Manhole Number	Cover Level	Connections	Pipe			Manhole Size	Types		
			Code	Inverts	Diams		Manhole	Cover	
S57	9.621		1	28.000	7.521	300	1200	Type B	
	Coordinates								D400
	E. 454309.770 N. 521410.719								
S58	9.323		1	22.000	8.273	150	1200	Type B	
	Coordinates								D400
	E. 454590.448 N. 521308.530								
S59	9.314		1	27.000	8.020	150	1200	Type B	
	Coordinates								D400
	E. 454601.103 N. 521275.969								
S60	9.630		1	1.010	6.800	600	1500	Type B	
	Coordinates								D400
	E. 454330.345 N. 521306.097								
S61	9.437		1	21.000	8.312	225	1200	Type B	
	Coordinates								D400
	E. 454526.774 N. 521374.719								
S62	9.680		1	29.000	8.630				

Rev.	Date	By	Check	Details	Appr.
P01	08/06/21	OC	EF	First Issue	PGK
P02	18/06/21	OC	EF	Updated to reflect new site layout	PGK
P03	15/02/23	JPS	AC	Foul schedule updated to suit revised layout	PGK

RAINWATER HARVESTING MANHOLE SCHEDULE

Manhole Number	Cover Level	Connections	Pipe			Manhole Size	Types	
			Code	Inverts	Diams		Manhole	Cover
<b>RHW1</b>	7.881 0.892		1 5.007	7.105	525	N/A	Headwall	N/A
E. 454396.069 N. 521262.417			0 5.008	6.989	525			
<b>R1</b>	9.391 1.050		1 6.000	8.541	150	1200	Type B	D400
E. 454409.964 N. 521423.479			0 6.000	8.416	150			
<b>R2</b>	9.391 0.976		1 6.001	8.416	150	1200	Type B	D400
E. 454427.272 N. 521432.853			0 6.001	8.235	150			
<b>R3</b>	9.538 1.378		1 6.001	8.235	150	1200	Type B	D400
E. 454438.024 N. 521408.059			0 6.002	8.160	225			
<b>R4</b>	9.426 1.382		1 6.002	8.044	225	1200	Type B	D400
E. 454461.604 N. 521418.294			0 6.003	8.044	225			
<b>R5</b>	9.402 1.604		1 8.001	8.033	225	1200	Type B	D400
E. 454476.586 N. 521383.916			0 6.004	7.798	300			
<b>R6</b>	9.391 1.760		1 5.001	8.083	225	1350	Type B	D400
E. 454487.611 N. 521358.499			0 5.002	7.631	375			
<b>R7</b>	9.486 1.946		1 5.002	7.540	375	1350	Type B	D400
E. 454459.120 N. 521344.444			0 5.003	7.540	375			
<b>R8</b>	9.491 2.068		1 5.003	7.499	375	1350	Type B	D400
E. 454465.342 N. 521330.111			0 5.004	7.424	450			
<b>R9</b>	9.471 2.105		1 5.004	7.366	450	1350	Type B	D400
E. 454476.729 N. 521303.877			0 5.005	7.366	450			
<b>R10</b>	10.965 3.629		1 5.005	7.336	450	1350	Type A	D400
E. 454462.927 N. 521297.886			0 5.006	7.336	450			
<b>R11</b>	9.287 2.168		1 5.006	7.194	450	1500	Type B	D400
E. 454397.888 N. 521268.654			0 5.007	7.119	525			
<b>R12</b>	9.500 1.050		1 5.000	8.450	150	1200	Type B	D400
E. 454421.186 N. 521400.750			0 7.000	8.450	150			
<b>R13</b>	9.449 1.050		1 8.000	8.399	150	1200	Type B	D400
E. 454516.675 N. 521401.318			0 8.000	8.163	150			
<b>R14</b>	9.471 1.383		1 8.001	8.088	225	1200	Type B	D400
E. 454484.230 N. 521387.234			0 8.001	8.121	225			
<b>R15</b>	9.498 1.125		1 5.000	8.373	225	1200	Type B	D400
E. 454546.764 N. 521381.160			0 5.000	8.121	225			
<b>R16</b>	9.493 1.371		1 5.001	8.121	225	1200	Type B	D400
E. 454495.947 N. 521359.102			0 9.000	8.369	150			
<b>R17</b>	9.419 1.050		1 9.000	8.369	150	1200	Type B	D400
E. 454354.437 N. 521400.034			0					

RAINWATER HARVESTING MANHOLE SCHEDULE

Manhole Number	Cover Level	Connections	Pipe			Manhole Size	Types	
			Code	Inverts	Diams		Manhole	Cover
<b>R18</b>	9.420 1.343		1 9.000	8.152	150	1200	Type B	D400
E. 454367.381 N. 521370.215			0 9.001	8.077	225			
<b>R19</b>	9.472 1.459		1 9.001	8.013	225	1200	Type B	D400
E. 454372.495 N. 521358.433			0 9.002	8.013	225			
<b>R20</b>	9.472 1.518		1 9.002	7.954	225	1200	Type B	D400
E. 454360.577 N. 521353.339			0 9.003	7.954	225			
<b>R21</b>	9.449 1.518		1 11.000	8.272	150	1200	Type B	D400
E. 454362.636 N. 521348.844			0 9.004	7.932	225			
<b>R22</b>	9.500 1.664		1 9.004	7.911	225	1200	Type B	D400
E. 454364.507 N. 521344.752			0 9.005	7.836	300			
<b>R23</b>	9.314 1.645		1 9.006	7.869	300	1200	Type B	D400
E. 454385.170 N. 521298.953			0 9.007	7.869	300			
<b>R24</b>	9.497 1.050		1 10.000	8.447	150	1200	Type B	D400
E. 454342.538 N. 521383.552			0 10.000	8.215	150			
<b>R25</b>	9.469 1.254		1 10.001	8.215	150	1200	Type B	D400
E. 454356.376 N. 521351.673			0 10.001	8.215	150			
<b>R26-HT</b>	9.462 1.140		1 11.000	8.322	150	1200	Type B	D400
E. 454368.498 N. 521351.773			0					

FOUL WATER MANHOLE SCHEDULE

Manhole Number	Cover Level	Connections	Pipe			Manhole Size	Types	
			Code	Inverts	Diams		Manhole	Cover
<b>F1</b>	9.431 1.350		1 Pumping Main 1	8.081	90	1200	Type B	D400
E. 454345.045 N. 521384.571			0 1.000	8.081	150			
<b>F2</b>	9.401 2.075		1 1.000	7.326	150	1200	Type B	D400
E. 454369.088 N. 521329.181			0 1.001	7.326	150			
<b>F3</b>	9.349 2.176		1 1.001	7.173	150	1200	Type B	D400
E. 454378.207 N. 521308.072			0 1.002	7.173	150			
<b>F4</b>	9.352 2.440		1 1.002	6.912	150	1200	Type B	D400
E. 454393.675 N. 521272.211			0 1.003	6.912	150			
<b>F5</b>	9.486 2.767		1 1.003	6.719	150	1200	Type B	D400
E. 454367.114 N. 521260.608			0 1.004	6.719	150			
<b>F6</b>	9.850 1.050		1 2.000	8.800	150	1200	Type B	D400
E. 454515.465 N. 521249.840			0 2.001	8.050	150			
<b>F7</b>	9.480 1.440		1 2.001	8.050	150	1200	Type B	D400
E. 454460.432 N. 521225.936			0 2.001	8.050	150			
<b>F8</b>	9.350 0.850		1 3.000	8.500	150	1200	Type B	D400
E. 454446.881 N. 521198.630			0 3.000	8.540	150			
<b>F9</b>	9.460 1.657		1 2.001	7.803	150	1200	Type B	D400
E. 454426.432 N. 521211.084			0 2.002	7.803	150			
<b>F10</b>	9.222 1.657		1 2.002	7.565	150	1200	Type B	D400
E. 454392.843 N. 521199.183			0 2.003	7.565	150			
<b>F11</b>	9.391 2.837		1 1.004	6.554	150	1200	Type B	D400
E. 454376.641 N. 521237.841			0 1.005	6.554	150			
<b>FPS2</b>	9.470 2.995		1 Pumping Main 2	6.475	90	Margreter Aquapump PC Horizontal Range		
E. 454370.684 N. 521220.750			0 Pumping Main 2	6.600	90			
<b>F12</b>	9.450 2.850		1 1.006	6.600	150	1200	Type B	D400
E. 454616.449 N. 521240.351			0 1.006	6.500	150			
<b>EX1</b>						Existing Manhole		
E. 454619.798 N. 521232.844								
<b>FPS1</b>	9.478 1.350		1 Pumping Main 1	8.128	90	Margreter Aquapump 1250L Domestic Pump Chamber		
E. 454417.657 N. 521491.775			0					

Status	Date	By	Check	Drawing Status	Details	Appr.

**PRELIMINARY  
DRAWING**

Project Title:  
TEES VALLEY EFW

Drawing Title:  
Proposed Drainage  
Manhole Schedule  
Rainwater Harvesting and Foul Water

Client/Architect: HZI  
 Drawn by: OC Date: June '21  
 Checked by: EF Scales: N/A  
 Approved by: PGK Sheet Size: A0

Project Number	Orig	Zone	Level	Type	Disc	Number	Revision
212018	DC	XX	XX	GA	C	321	P03



## APPENDIX D:

Rev.	Date	By	Check	Details	Appr.
P01	09.02.21	OC	AC	First Issue	PGK
P02	28.01.22	BMCC	AC	Catchment areas updated to suit revised site layout.	PGK
P03	25.03.22	BMCC	AC	Site layout amended.	PGK

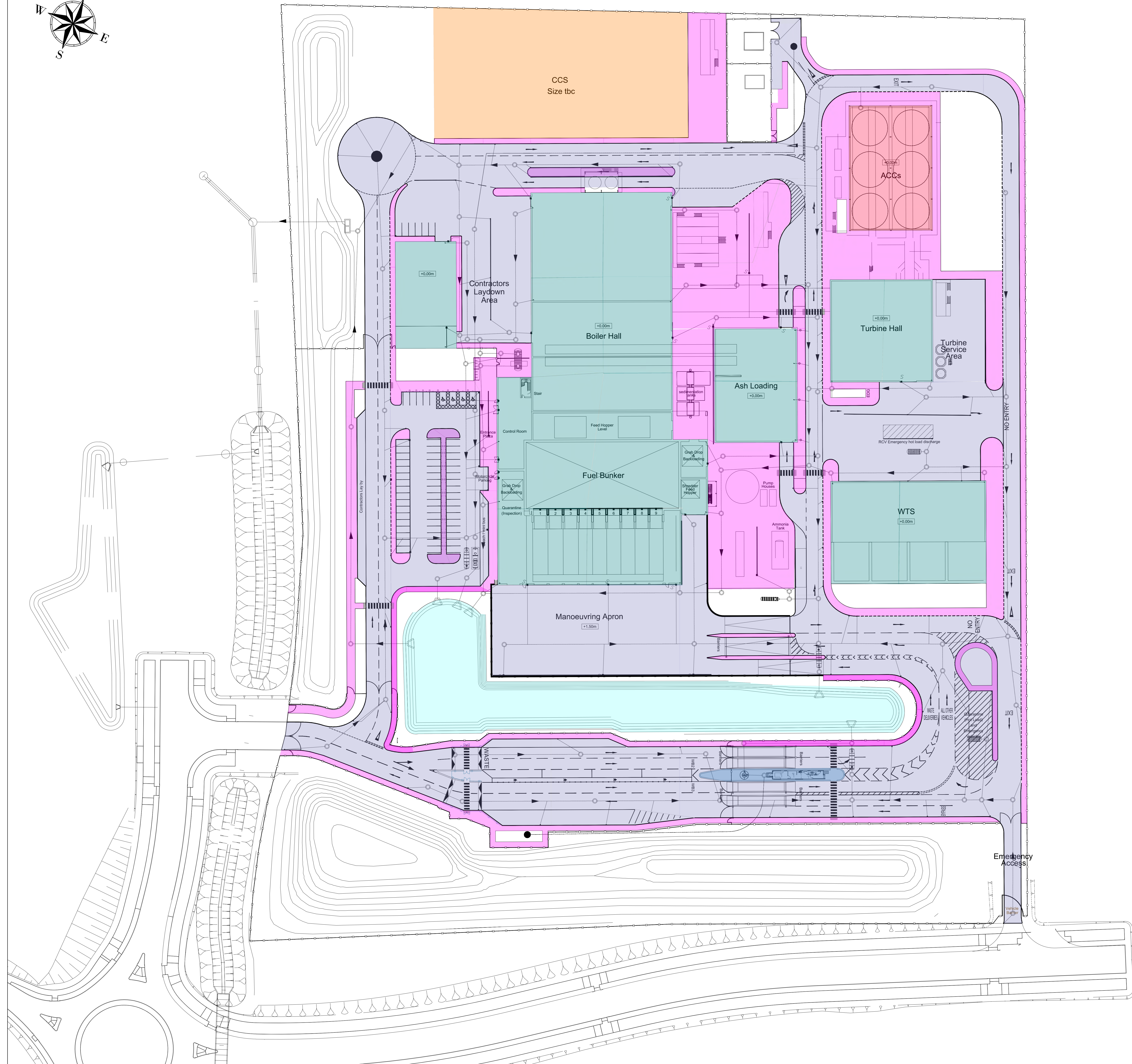
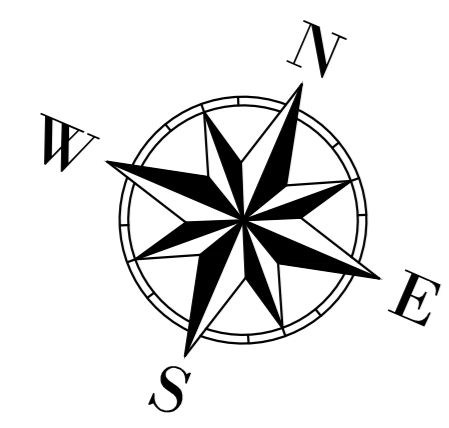

**Legend**

- Building Footprint (100% Impermeable)
- Highway (100% Impermeable)
- Footpath (100% Impermeable)
- Gravel Area (100% Impermeable)
- Potential Future Expansion (90% Impermeable)
- Attenuation Pond (100% Impermeable)

Status	Date	By	Check	Drawing Status	Details	Appr.

**PRELIMINARY DRAWING**

Project Title:  
**TEES VALLEY EFW**

Drawing Title:  
**Proposed Drainage Catchments**

Client/Architect:	H2I	Date:	June '21
Drawn by:	OC	Checked by:	EF
Scale:	1:500	Sheet Size:	A0
Approved by:	PGK		

Project Number	Orig	Zone	Level	Type	Disc	Number	Revision
212018	DC	XX	XX	GA	C	302	P03

**Doran CONSULTING**  
DELIVERING ENGINEERING EXCELLENCE

Nowwood House  
99-103 Great Victoria Street,  
Belfast BT2 7BE  
T: 028 90333443  
F: 028 90220501  
E: mail@doran.co.uk  
W: www.doran.co.uk



## APPENDIX E:

Doran Consulting Limited		Page 1
Norwood House 96-102 Great Victoria Street Belfast, BT2 7BE		
Date 09/07/2021 12:09 File 202018 - MD - 210611.MDX	Designed by 645 Checked by	
Innovyze		Network 2019.1

STORM SEWER DESIGN by the Modified Rational Method

Design Criteria for PR-Storm

Pipe Sizes STANDARD Manhole Sizes STANDARD









FSR Rainfall Model - England and Wales

Return Period (years)	200	PIMP (%)	100
M5-60 (mm)	18.000	Add Flow / Climate Change (%)	0
Ratio R	0.350	Minimum Backdrop Height (m)	0.000
Maximum Rainfall (mm/hr)	50	Maximum Backdrop Height (m)	0.000
Maximum Time of Concentration (mins)	30	Min Design Depth for Optimisation (m)	0.900
Foul Sewage (l/s/ha)	0.000	Min Vel for Auto Design only (m/s)	1.00
Volumetric Runoff Coeff.	0.750	Min Slope for Optimisation (1:X)	500

Designed with Level Soffits

Network Design Table for PR-Storm

« - Indicates pipe capacity < flow















PN	Length (m)	Fall (m)	Slope (1:X)	I.Area (ha)	T.E. (mins)	Base Flow (l/s)	k (mm)	HYD SECT	DIA (mm)	Section Type	Auto Design
S1.000	40.365	0.269	150.0	0.056	5.00	0.0	0.600	o	300	Pipe/Conduit	
S1.001	51.101	0.232	220.0	0.083	0.00	0.0	0.600	o	300	Pipe/Conduit	
S1.002	46.073	0.209	220.0	0.106	0.00	0.0	0.600	o	300	Pipe/Conduit	
S2.000	27.098	0.181	150.0	0.051	5.00	0.0	0.600	o	225	Pipe/Conduit	
S2.001	58.230	0.265	220.0	0.065	0.00	0.0	0.600	o	225	Pipe/Conduit	
S1.003	29.461	0.098	300.0	0.073	0.00	0.0	0.600	o	300	Pipe/Conduit	
S3.000	53.952	0.360	150.0	0.077	5.00	0.0	0.600	o	225	Pipe/Conduit	
S3.001	25.788	0.117	220.0	0.053	0.00	0.0	0.600	o	300	Pipe/Conduit	

Network Results Table

PN	Rain (mm/hr)	T.C. (mins)	US/IL (m)	Σ I.Area (ha)	Σ Base Flow (l/s)	Foul (l/s)	Add Flow (l/s)	Vel (m/s)	Cap (l/s)	Flow (l/s)
S1.000	50.00	5.52	8.368	0.056	0.0	0.0	0.0	1.28	90.6	7.6
S1.001	50.00	6.33	8.099	0.140	0.0	0.0	0.0	1.06	74.6	18.9
S1.002	50.00	7.06	7.867	0.246	0.0	0.0	0.0	1.06	74.6	33.3
S2.000	50.00	5.42	7.945	0.051	0.0	0.0	0.0	1.07	42.4	6.9
S2.001	50.00	6.53	7.764	0.116	0.0	0.0	0.0	0.88	34.9	15.7
S1.003	50.00	7.60	7.425	0.434	0.0	0.0	0.0	0.90	63.8	58.8
S3.000	50.00	5.84	8.353	0.077	0.0	0.0	0.0	1.07	42.4	10.4
S3.001	50.00	6.25	7.918	0.130	0.0	0.0	0.0	1.06	74.6	17.6

Doran Consulting Limited		Page 2
Norwood House 96-102 Great Victoria Street Belfast, BT2 7BE		
Date 09/07/2021 12:09 File 202018 - MD - 210611.MDX	Designed by 645 Checked by	
Innovyze		Network 2019.1

Network Design Table for PR-Storm















PN	Length (m)	Fall (m)	Slope (1:X)	I.Area (ha)	T.E. (mins)	Base Flow (l/s)	k (mm)	HYD SECT	DIA (mm)	Section Type	Auto Design
S3.002	18.652	0.062	300.0	0.090	0.00	0.0	0.600	o	300	Pipe/Conduit	
S3.003	42.696	0.142	300.0	0.154	0.00	0.0	0.600	o	300	Pipe/Conduit	
S4.000	17.904	0.119	150.0	0.000	5.00	0.0	0.600	o	150	Pipe/Conduit	
S3.004	10.531	0.035	300.0	0.000	0.00	0.0	0.600	o	300	Pipe/Conduit	
S3.005	62.804	0.209	300.0	0.119	0.00	0.0	0.600	o	375	Pipe/Conduit	
S1.004	11.221	0.022	500.0	0.085	0.00	0.0	0.600	o	450	Pipe/Conduit	
S1.005	11.137	0.022	500.0	0.000	0.00	0.0	0.600	o	450	Pipe/Conduit	
S1.006	7.321	0.015	500.0	0.000	0.00	0.0	0.600	o	450	Pipe/Conduit	
S1.007	19.175	0.002	9001.0	0.000	0.00	0.0	0.600	o	450	Pipe/Conduit	
S5.000	55.398	0.252	220.0	0.116	5.00	0.0	0.600	o	225	Pipe/Conduit	
S5.001	8.358	0.038	220.0	0.092	0.00	0.0	0.600	o	225	Pipe/Conduit	
S6.000	18.814	0.125	150.0	0.076	5.00	0.0	0.600	o	150	Pipe/Conduit	
S6.001	27.025	0.180	150.0	0.000	0.00	0.0	0.600	o	225	Pipe/Conduit	
S7.000	18.355	0.122	150.0	0.087	5.00	0.0	0.600	o	225	Pipe/Conduit	
S6.002	25.706	0.117	220.0	0.000	0.00	0.0	0.600	o	300	Pipe/Conduit	

Network Results Table

PN	Rain (mm/hr)	T.C. (mins)	US/IL (m)	I.Area (ha)	Base Flow (l/s)	Foul (l/s)	Add Flow (l/s)	Vel (m/s)	Cap (l/s)	Flow (l/s)
S3.002	50.00	6.60	7.801	0.219	0.0	0.0	0.0	0.90	63.8	29.7
S3.003	50.00	7.38	7.739	0.373	0.0	0.0	0.0	0.90	63.8	50.5
S4.000	50.00	5.36	8.356	0.000	0.0	0.0	0.0	0.82	14.5	0.0
S3.004	50.00	7.58	7.597	0.373	0.0	0.0	0.0	0.90	63.8	50.5
S3.005	50.00	8.58	7.487	0.492	0.0	0.0	0.0	1.04	115.0	66.6
S1.004	50.00	8.79	7.176	1.011	0.0	0.0	0.0	0.90	143.5	136.9
S1.005	50.00	9.00	7.154	1.011	0.0	0.0	0.0	0.90	143.5	136.9
S1.006	50.00	9.13	7.132	1.011	0.0	0.0	0.0	0.90	143.5	136.9
S1.007	50.00	10.69	7.000	1.011	0.0	0.0	0.0	0.20	32.6	136.9
S5.000	50.00	6.05	8.373	0.116	0.0	0.0	0.0	0.88	34.9	15.7
S5.001	50.00	6.21	8.121	0.208	0.0	0.0	0.0	0.88	34.9	28.1
S6.000	50.00	5.38	8.541	0.076	0.0	0.0	0.0	0.82	14.5	10.3
S6.001	50.00	5.81	8.341	0.076	0.0	0.0	0.0	1.07	42.4	10.3
S7.000	50.00	5.29	8.450	0.087	0.0	0.0	0.0	1.07	42.4	11.8
S6.002	50.00	6.21	8.085	0.163	0.0	0.0	0.0	1.06	74.6	22.1

















Network Design Table for PR-Storm

PN	Length (m)	Fall (m)	Slope (1:X)	I.Area (ha)	T.E. (mins)	Base Flow (l/s)	k (mm)	HYD SECT	DIA (mm)	Section Type	Auto Design
S6.003	37.501	0.170	220.0	0.057	0.00	0.0	0.600	o	300	Pipe/Conduit	
S8.000	35.370	0.236	150.0	0.066	5.00	0.0	0.600	o	150	Pipe/Conduit	
S8.001	8.332	0.056	150.0	0.071	0.00	0.0	0.600	o	225	Pipe/Conduit	
S6.004	27.705	0.092	300.0	0.066	0.00	0.0	0.600	o	300	Pipe/Conduit	
S5.002	31.769	0.091	349.1	0.000	0.00	0.0	0.600	o	375	Pipe/Conduit	
S5.003	15.626	0.041	379.1	0.000	0.00	0.0	0.600	o	375	Pipe/Conduit	
S5.004	28.599	0.057	500.0	0.170	0.00	0.0	0.600	o	450	Pipe/Conduit	
S5.005	15.047	0.030	500.0	0.000	0.00	0.0	0.600	o	450	Pipe/Conduit	
S5.006	70.902	0.142	500.0	0.095	0.00	0.0	0.600	o	450	Pipe/Conduit	
S9.000	32.507	0.217	150.0	0.080	5.00	0.0	0.600	o	225	Pipe/Conduit	
S9.001	12.844	0.064	200.0	0.091	0.00	0.0	0.600	o	225	Pipe/Conduit	
S9.002	12.961	0.059	220.0	0.000	0.00	0.0	0.600	o	225	Pipe/Conduit	
S10.000	34.754	0.232	150.0	0.082	5.00	0.0	0.600	o	150	Pipe/Conduit	
S10.001	4.519	0.030	150.0	0.000	0.00	0.0	0.600	o	150	Pipe/Conduit	
S9.003	4.944	0.022	220.0	0.000	0.00	0.0	0.600	o	225	Pipe/Conduit	

Network Results Table

PN	Rain (mm/hr)	T.C. (mins)	US/IL (m)	Σ I.Area (ha)	Σ Base Flow (l/s)	Foul (l/s)	Add Flow (l/s)	Vel (m/s)	Cap (l/s)	Flow (l/s)
S6.003	50.00	6.80	7.969	0.220	0.0	0.0	0.0	1.06	74.6	29.8
S8.000	50.00	5.72	8.399	0.066	0.0	0.0	0.0	0.82	14.5	8.9
S8.001	50.00	5.85	8.088	0.136	0.0	0.0	0.0	1.07	42.4	18.5
S6.004	50.00	7.32	7.798	0.423	0.0	0.0	0.0	0.90	63.8	57.2
S5.002	50.00	7.86	7.631	0.630	0.0	0.0	0.0	0.96	106.5	85.4
S5.003	50.00	8.15	7.540	0.630	0.0	0.0	0.0	0.92	102.1	85.4
S5.004	50.00	8.67	7.424	0.800	0.0	0.0	0.0	0.90	143.5	108.4
S5.005	50.00	8.95	7.366	0.800	0.0	0.0	0.0	0.90	143.5	108.4
S5.006	50.00	10.26	7.336	0.895	0.0	0.0	0.0	0.90	143.5	121.2
S9.000	50.00	5.51	8.369	0.080	0.0	0.0	0.0	1.07	42.4	10.8
S9.001	50.00	5.74	8.152	0.171	0.0	0.0	0.0	0.92	36.6	23.1
S9.002	50.00	5.99	8.088	0.171	0.0	0.0	0.0	0.88	34.9	23.1
S10.000	50.00	5.71	8.447	0.082	0.0	0.0	0.0	0.82	14.5	11.1
S10.001	50.00	5.80	8.215	0.082	0.0	0.0	0.0	0.82	14.5	11.1
S9.003	50.00	6.08	8.029	0.253	0.0	0.0	0.0	0.88	34.9	34.2

Network Design Table for PR-Storm

PN	Length (m)	Fall (m)	Slope (1:X)	I.Area (ha)	T.E. (mins)	Base Flow (l/s)	k (mm)	HYD SECT	DIA (mm)	Section Type	Auto Design
S11.000	7.459	0.050	150.0	0.000	5.00	0.0	0.600	o	150	Pipe/Conduit	
S9.004	4.500	0.020	220.0	0.000	0.00	0.0	0.600	o	225	Pipe/Conduit	
S9.005	30.279	0.101	300.0	0.000	0.00	0.0	0.600	o	300	Pipe/Conduit	
S9.006	19.977	0.067	300.0	0.170	0.00	0.0	0.600	o	300	Pipe/Conduit	
S9.007	31.940	0.106	300.0	0.000	0.00	0.0	0.600	o	300	Pipe/Conduit	
S5.007	7.462	0.015	500.0	0.089	0.00	0.0	0.600	o	525	Pipe/Conduit	
S5.008	25.572	0.003	9001.0	0.000	0.00	0.0	0.600	o	525	Pipe/Conduit	
S12.000	25.580	0.128	200.0	0.037	5.00	0.0	0.600	o	225	Pipe/Conduit	
S13.000	7.000	0.050	140.6	0.135	5.00	0.0	0.600	o	225	Pipe/Conduit	
S12.001	14.462	0.072	200.0	0.000	0.00	0.0	0.600	o	225	Pipe/Conduit	
S14.000	22.627	0.151	150.0	0.039	5.00	0.0	0.600	o	150	Pipe/Conduit	
S12.002	21.952	0.146	150.0	0.028	0.00	0.0	0.600	o	375	Pipe/Conduit	
S12.003	61.110	0.204	300.0	0.406	0.00	0.0	0.600	o	450	Pipe/Conduit	
S15.000	36.424	0.243	150.0	0.155	5.00	0.0	0.600	o	225	Pipe/Conduit	

Network Results Table

PN	Rain (mm/hr)	T.C. (mins)	US/IL (m)	Σ I.Area (ha)	Σ Base Flow (l/s)	Foul (l/s)	Add Flow (l/s)	Vel (m/s)	Cap (l/s)	Flow (l/s)
S11.000	50.00	5.15	8.322	0.000	0.0	0.0	0.0	0.82	14.5	0.0
S9.004	50.00	6.17	8.007	0.253	0.0	0.0	0.0	0.88	34.9	34.2
S9.005	50.00	6.73	7.911	0.253	0.0	0.0	0.0	0.90	63.8	34.2
S9.006	50.00	7.09	7.810	0.423	0.0	0.0	0.0	0.90	63.8	57.2
S9.007	50.00	7.68	7.744	0.423	0.0	0.0	0.0	0.90	63.8	57.2
S5.007	50.00	10.39	7.119	1.407	0.0	0.0	0.0	0.99	215.4	190.5
S5.008	50.00	12.27	6.989	1.407	0.0	0.0	0.0	0.23	49.0	190.5
S12.000	50.00	5.46	8.456	0.037	0.0	0.0	0.0	0.92	36.6	5.0
S13.000	50.00	5.11	8.630	0.135	0.0	0.0	0.0	1.10	43.8	18.3
S12.001	50.00	5.72	8.328	0.172	0.0	0.0	0.0	0.92	36.6	23.2
S14.000	50.00	5.46	8.428	0.039	0.0	0.0	0.0	0.82	14.5	5.2
S12.002	50.00	5.97	8.052	0.238	0.0	0.0	0.0	1.48	163.1	32.3
S12.003	50.00	6.84	7.831	0.644	0.0	0.0	0.0	1.17	185.8	87.3
S15.000	50.00	5.57	8.453	0.155	0.0	0.0	0.0	1.07	42.4	21.0

Norwood House  
96-102 Great Victoria Street  
Belfast, BT2 7BE



Date 09/07/2021 12:09  
File 202018 - MD - 210611.MDX

Designed by 645  
Checked by

Innovyze

Network 2019.1













Network Design Table for PR-Storm

PN	Length (m)	Fall (m)	Slope (1:X)	I.Area (ha)	T.E. (mins)	Base Flow (l/s)	k (mm)	HYD SECT	DIA (mm)	Section Type	Auto Design
S12.004	26.885	0.054	500.0	0.049	0.00	0.0	0.600	o	450	Pipe/Conduit	
S12.005	23.138	0.046	500.0	0.000	0.00	0.0	0.600	o	450	Pipe/Conduit	
S16.000	34.249	0.228	150.0	0.023	5.00	0.0	0.600	o	150	Pipe/Conduit	
S12.006	51.492	0.103	500.0	0.070	0.00	0.0	0.600	o	525	Pipe/Conduit	
S17.000	2.783	0.014	200.0	0.150	5.00	0.0	0.600	o	225	Pipe/Conduit	
S17.001	10.482	0.048	220.0	0.000	0.00	0.0	0.600	o	225	Pipe/Conduit	
S12.007	16.140	0.032	500.0	0.000	0.00	0.0	0.600	o	525	Pipe/Conduit	
S18.000	68.558	1.139	60.2	0.236	5.00	0.0	0.600	o	450	Pipe/Conduit	
S19.000	43.007	1.412	30.5	0.024	5.00	0.0	0.600	o	225	Pipe/Conduit	
S18.001	44.850	0.747	60.0	0.054	0.00	0.0	0.600	o	450	Pipe/Conduit	
S20.000	73.635	0.335	220.0	0.157	5.00	0.0	0.600	o	300	Pipe/Conduit	
S21.000	28.863	0.195	148.0	0.278	5.00	0.0	0.600	o	300	Pipe/Conduit	

Network Results Table

PN	Rain (mm/hr)	T.C. (mins)	US/IL (m)	Σ I.Area (ha)	Σ Base Flow (l/s)	Foul (l/s)	Add Flow (l/s)	Vel (m/s)	Cap (l/s)	Flow (l/s)
S12.004	50.00	7.34	7.627	0.848	0.0	0.0	0.0	0.90	143.5	114.9
S12.005	50.00	7.77	7.573	0.848	0.0	0.0	0.0	0.90	143.5	114.9
S16.000	50.00	5.70	8.435	0.023	0.0	0.0	0.0	0.82	14.5	3.1
S12.006	50.00	8.63	7.452	0.941	0.0	0.0	0.0	0.99	215.4	127.4
S17.000	50.00	5.05	8.737	0.150	0.0	0.0	0.0	0.92	36.6	20.4
S17.001	50.00	5.25	8.723	0.150	0.0	0.0	0.0	0.88	34.9	20.4
S12.007	50.00	8.90	7.349	1.091	0.0	0.0	0.0	0.99	215.4	147.8
S18.000	50.00	5.44	9.077	0.236	0.0	0.0	0.0	2.62	417.3	32.0
S19.000	50.00	5.30	9.575	0.024	0.0	0.0	0.0	2.38	94.6	3.3
S18.001	50.00	5.72	7.938	0.315	0.0	0.0	0.0	2.63	417.9	42.6
S20.000	50.00	6.16	8.053	0.157	0.0	0.0	0.0	1.06	74.6	21.3
S21.000	50.00	5.37	8.178	0.278	0.0	0.0	0.0	1.29	91.2	37.6















Network Design Table for PR-Storm

PN	Length (m)	Fall (m)	Slope (1:X)	I.Area (ha)	T.E. (mins)	Base Flow (l/s)	k (mm)	HYD SECT	DIA (mm)	Section Type	Auto Design
S20.001	25.211	0.072	350.0	0.006	0.00	0.0	0.600	o	375	Pipe/Conduit	
S22.000	28.863	0.144	200.0	0.000	5.00	0.0	0.600	o	225	Pipe/Conduit	
S20.002	61.203	0.122	500.0	0.104	0.00	0.0	0.600	o	450	Pipe/Conduit	
S23.000	25.038	0.167	150.0	0.046	5.00	0.0	0.600	o	150	Pipe/Conduit	
S20.003	23.736	0.047	500.0	0.018	0.00	0.0	0.600	o	450	Pipe/Conduit	
S24.000	9.623	1.151	8.4	0.047	5.00	0.0	0.600	o	150	Pipe/Conduit	
S20.004	44.737	0.089	500.0	0.008	0.00	0.0	0.600	o	450	Pipe/Conduit	
S12.008	5.134	0.010	500.0	0.160	0.00	0.0	0.600	o	600	Pipe/Conduit	
S12.009	5.134	0.010	500.0	0.000	0.00	0.0	0.600	o	600	Pipe/Conduit	
S12.010	7.371	0.015	500.0	0.000	0.00	0.0	0.600	o	600	Pipe/Conduit	
S12.011	149.216	0.017	9001.0	0.000	0.00	0.0	0.600	o	1200	Pipe/Conduit	
S25.000	13.444	0.090	150.0	0.002	5.00	0.0	0.600	o	150	Pipe/Conduit	
S25.001	47.844	0.159	300.0	0.109	0.00	0.0	0.600	o	300	Pipe/Conduit	

Network Results Table

PN	Rain (mm/hr)	T.C. (mins)	US/IL (m)	Σ I.Area (ha)	Σ Base Flow (l/s)	Foul (l/s)	Add Flow (l/s)	Vel (m/s)	Cap (l/s)	Flow (l/s)
S20.001	50.00	6.60	7.643	0.440	0.0	0.0	0.0	0.96	106.3	59.6
S22.000	50.00	5.52	8.312	0.000	0.0	0.0	0.0	0.92	36.6	0.0
S20.002	50.00	7.73	7.496	0.545	0.0	0.0	0.0	0.90	143.5	73.8
S23.000	50.00	5.51	8.273	0.046	0.0	0.0	0.0	0.82	14.5	6.2
S20.003	50.00	8.17	7.374	0.609	0.0	0.0	0.0	0.90	143.5	82.5
S24.000	50.00	5.05	8.732	0.047	0.0	0.0	0.0	3.51	62.0	6.4
S20.004	50.00	8.99	7.281	0.664	0.0	0.0	0.0	0.90	143.5	89.9
S12.008	50.00	9.07	7.041	2.231	0.0	0.0	0.0	1.08	306.0	302.0
S12.009	50.00	9.15	7.031	2.231	0.0	0.0	0.0	1.08	306.0	302.0
S12.010	50.00	9.27	7.020	2.231	0.0	0.0	0.0	1.08	306.0	302.0
S12.011	50.00	15.74	6.977	2.231	0.0	0.0	0.0	0.38	434.3	302.0
S25.000	50.00	5.27	8.307	0.002	0.0	0.0	0.0	0.82	14.5	0.3
S25.001	50.00	6.16	8.067	0.111	0.0	0.0	0.0	0.90	63.8	15.0

Network Design Table for PR-Storm





PN	Length (m)	Fall (m)	Slope (1:X)	I.Area (ha)	T.E. (mins)	Base Flow (l/s)	k (mm)	HYD SECT	DIA (mm)	Section Type	Auto Design
S25.002	45.119	0.150	300.0	0.069	0.00	0.0	0.600	o	300	Pipe/Conduit	
S26.000	45.406	0.151	300.0	0.069	5.00	0.0	0.600	o	300	Pipe/Conduit	
S26.001	45.119	0.150	300.0	0.058	0.00	0.0	0.600	o	300	Pipe/Conduit	
S26.002	17.573	0.059	300.0	0.030	0.00	0.0	0.600	o	300	Pipe/Conduit	
S25.003	47.673	0.268	177.6	0.078	0.00	0.0	0.600	o	300	Pipe/Conduit	
S27.000	40.942	0.273	150.0	0.027	5.00	0.0	0.600	o	225	Pipe/Conduit	
S28.000	15.641	0.104	150.0	0.025	5.00	0.0	0.600	o	225	Pipe/Conduit	
S27.001	40.529	0.270	150.0	0.143	0.00	0.0	0.600	o	300	Pipe/Conduit	
S25.004	9.176	0.031	300.0	0.000	0.00	0.0	0.600	o	375	Pipe/Conduit	
S25.005	5.653	0.019	300.0	0.030	0.00	0.0	0.600	o	375	Pipe/Conduit	
S25.006	5.653	0.019	300.0	0.000	0.00	0.0	0.600	o	375	Pipe/Conduit	
S25.007	6.117	0.020	300.0	0.000	0.00	0.0	0.600	o	375	Pipe/Conduit	
S25.008	162.573	0.018	9001.0	0.000	0.00	0.0	0.600	o	1200	Pipe/Conduit	
S1.008	20.812	0.042	500.0	0.413	0.00	0.0	0.600	o	600	Pipe/Conduit	
S1.009	78.294	0.157	500.0	0.000	0.00	0.0	0.600	o	600	Pipe/Conduit	

Network Results Table

PN	Rain (mm/hr)	T.C. (mins)	US/IL (m)	Σ I.Area (ha)	Σ Base Flow (l/s)	Foul (l/s)	Add Flow (l/s)	Vel (m/s)	Cap (l/s)	Flow (l/s)
S25.002	50.00	6.99	7.908	0.180	0.0	0.0	0.0	0.90	63.8	24.4
S26.000	50.00	5.84	8.147	0.069	0.0	0.0	0.0	0.90	63.8	9.3
S26.001	50.00	6.67	7.996	0.127	0.0	0.0	0.0	0.90	63.8	17.2
S26.002	50.00	7.00	7.936	0.157	0.0	0.0	0.0	0.90	63.8	21.3
S25.003	50.00	7.67	7.757	0.415	0.0	0.0	0.0	1.18	83.2	56.2
S27.000	50.00	5.64	8.122	0.027	0.0	0.0	0.0	1.07	42.4	3.6
S28.000	50.00	5.24	8.020	0.025	0.0	0.0	0.0	1.07	42.4	3.5
S27.001	50.00	6.17	7.774	0.195	0.0	0.0	0.0	1.28	90.6	26.4
S25.004	50.00	7.82	7.414	0.610	0.0	0.0	0.0	1.04	115.0	82.6
S25.005	50.00	7.91	7.383	0.640	0.0	0.0	0.0	1.04	115.0	86.6
S25.006	50.00	8.00	7.365	0.640	0.0	0.0	0.0	1.04	115.0	86.6
S25.007	50.00	8.10	7.346	0.640	0.0	0.0	0.0	1.04	115.0	86.6
S25.008	50.00	15.15	7.169	0.640	0.0	0.0	0.0	0.38	434.3	86.6
S1.008	50.00	16.06	7.000	5.701	0.0	0.0	0.0	1.08	306.0	772.0
S1.009	50.00	17.27	6.957	5.701	0.0	0.0	0.0	1.08	306.0	772.0

Doran Consulting Limited		Page 8
Norwood House 96-102 Great Victoria Street Belfast, BT2 7BE		
Date 09/07/2021 12:09 File 202018 - MD - 210611.MDX	Designed by 645 Checked by	
Innovyze		Network 2019.1

Network Design Table for PR-Storm

PN	Length (m)	Fall (m)	Slope (1:X)	I.Area (ha)	T.E. (mins)	Base Flow (l/s)	k (mm)	HYD SECT	DIA (mm)	Section Type	Auto Design
S1.010	70.715	0.141	500.0	0.000	0.00	0.0	0.600	o	600	Pipe/Conduit	
S29.000	39.085	0.130	300.0	0.381	5.00	0.0	0.600	o	375	Pipe/Conduit	
S1.011	5.855	0.012	500.0	0.000	0.00	0.0	0.600	o	600	Pipe/Conduit	
S1.012	33.056	0.066	500.0	0.000	0.00	0.0	0.600	o	600	Pipe/Conduit	

Network Results Table

PN	Rain (mm/hr)	T.C. (mins)	US/IL (m)	Σ I.Area (ha)	Σ Base Flow (l/s)	Foul (l/s)	Add Flow (l/s)	Vel (m/s)	Cap (l/s)	Flow (l/s)
S1.010	50.00	18.36	6.800	5.701	0.0	0.0	0.0	1.08	306.0<	772.0
S29.000	50.00	5.63	7.446	0.381	0.0	0.0	0.0	1.04	115.0	51.6
S1.011	50.00	18.45	6.651	6.083	0.0	0.0	0.0	1.08	306.0<	823.7
S1.012	50.00	18.96	6.641	6.083	0.0	0.0	0.0	1.08	306.0<	823.7

PIPELINE SCHEDULES for PR-Storm

Upstream Manhole

PN	Hyd Sect	Diam (mm)	MH Name	C.Level (m)	I.Level (m)	D.Depth (m)	MH Connection	MH DIAM., L*W (mm)
S1.000	o	300	S4a	9.568	8.368	0.900	Open Manhole	1200
S1.001	o	300	S4	9.555	8.099	1.156	Open Manhole	1200
S1.002	o	300	S5a	9.528	7.867	1.361	Open Manhole	1200
S2.000	o	225	S38	9.070	7.945	0.900	Open Manhole	1200
S2.001	o	225	S16	9.166	7.764	1.176	Open Manhole	1200
S1.003	o	300	S5	9.420	7.425	1.695	Open Manhole	1200
S3.000	o	225	S1	9.478	8.353	0.900	Open Manhole	1200
S3.001	o	300	S2	9.488	7.918	1.269	Open Manhole	1200
S3.002	o	300	S3	9.402	7.801	1.301	Open Manhole	1200
S3.003	o	300	S11	9.463	7.739	1.424	Open Manhole	1200
S4.000	o	150	S15	9.406	8.356	0.900	Open Manhole	1200
S3.004	o	300	S12	9.472	7.597	1.575	Open Manhole	1200
S3.005	o	375	S13	9.500	7.487	1.638	Open Manhole	1350
S1.004	o	450	S6	9.423	7.176	1.796	Open Manhole	1350
S1.005	o	450	SPI1	9.434	7.154	1.830	Open Manhole	1350

Downstream Manhole

PN	Length (m)	Slope (1:X)	MH Name	C.Level (m)	I.Level (m)	D.Depth (m)	MH Connection	MH DIAM., L*W (mm)
S1.000	40.365	150.0	S4	9.555	8.099	1.156	Open Manhole	1200
S1.001	51.101	220.0	S5a	9.528	7.867	1.361	Open Manhole	1200
S1.002	46.073	220.0	S5	9.420	7.657	1.463	Open Manhole	1200
S2.000	27.098	150.0	S16	9.166	7.764	1.176	Open Manhole	1200
S2.001	58.230	220.0	S5	9.420	7.500	1.695	Open Manhole	1200
S1.003	29.461	300.0	S6	9.423	7.326	1.796	Open Manhole	1350
S3.000	53.952	150.0	S2	9.488	7.993	1.269	Open Manhole	1200
S3.001	25.788	220.0	S3	9.402	7.801	1.301	Open Manhole	1200
S3.002	18.652	300.0	S11	9.463	7.739	1.424	Open Manhole	1200
S3.003	42.696	300.0	S12	9.472	7.597	1.575	Open Manhole	1200
S4.000	17.904	150.0	S12	9.472	8.237	1.085	Open Manhole	1200
S3.004	10.531	300.0	S13	9.500	7.562	1.638	Open Manhole	1350
S3.005	62.804	300.0	S6	9.423	7.277	1.771	Open Manhole	1350
S1.004	11.221	500.0	SPI1	9.434	7.154	1.830	Open Manhole	1350
S1.005	11.137	500.0	S7	9.505	7.132	1.923	Open Manhole	1350

Norwood House  
 96-102 Great Victoria Street  
 Belfast, BT2 7BE



Date 09/07/2021 12:09  
 File 202018 - MD - 210611.MDX

Designed by 645  
 Checked by

Innovyze Network 2019.1

PIPELINE SCHEDULES for PR-Storm

Upstream Manhole

PN	Hyd Sect	Diam (mm)	MH Name	C.Level (m)	I.Level (m)	D.Depth (m)	MH Connection	MH DIAM., L*W (mm)
S1.006	o	450	S7	9.505	7.132	1.923	Open Manhole	1350
S1.007	o	450	SHW1	8.687	7.000	1.237	Junction	
S5.000	o	225	R15	9.498	8.373	0.900	Open Manhole	1200
S5.001	o	225	R16	9.493	8.121	1.146	Open Manhole	1200
S6.000	o	150	R1	9.591	8.541	0.900	Open Manhole	1200
S6.001	o	225	R2	9.391	8.341	0.826	Open Manhole	1200
S7.000	o	225	R12	9.500	8.450	0.825	Open Manhole	1200
S6.002	o	300	R3	9.538	8.085	1.153	Open Manhole	1200
S6.003	o	300	R4	9.426	7.969	1.157	Open Manhole	1200
S8.000	o	150	R13	9.449	8.399	0.900	Open Manhole	1200
S8.001	o	225	R14	9.471	8.088	1.158	Open Manhole	1200
S6.004	o	300	R5	9.402	7.798	1.304	Open Manhole	1200
S5.002	o	375	R6	9.391	7.631	1.385	Open Manhole	1350
S5.003	o	375	R7	9.486	7.540	1.571	Open Manhole	1350

Downstream Manhole

PN	Length (m)	Slope (1:X)	MH Name	C.Level (m)	I.Level (m)	D.Depth (m)	MH Connection	MH DIAM., L*W (mm)
S1.006	7.321	500.0	SHW1	8.687	7.117	1.120	Junction	
S1.007	19.175	9001.0	SHW4-POND	9.300	6.998	1.852	Junction	
S5.000	55.398	220.0	R16	9.493	8.121	1.146	Open Manhole	1200
S5.001	8.358	220.0	R6	9.391	8.083	1.083	Open Manhole	1350
S6.000	18.814	150.0	R2	9.391	8.416	0.826	Open Manhole	1200
S6.001	27.025	150.0	R3	9.538	8.160	1.153	Open Manhole	1200
S7.000	18.355	150.0	R3	9.538	8.328	0.986	Open Manhole	1200
S6.002	25.706	220.0	R4	9.426	7.969	1.157	Open Manhole	1200
S6.003	37.501	220.0	R5	9.402	7.798	1.304	Open Manhole	1200
S8.000	35.370	150.0	R14	9.471	8.163	1.158	Open Manhole	1200
S8.001	8.332	150.0	R5	9.402	8.033	1.145	Open Manhole	1200
S6.004	27.705	300.0	R6	9.391	7.706	1.385	Open Manhole	1350
S5.002	31.769	349.1	R7	9.486	7.540	1.571	Open Manhole	1350
S5.003	15.626	379.1	R8	9.491	7.499	1.618	Open Manhole	1350



PIPELINE SCHEDULES for PR-Storm

Upstream Manhole

PN	Hyd Sect	Diam (mm)	MH Name	C.Level (m)	I.Level (m)	D.Depth (m)	MH Connection	MH DIAM., L*W (mm)
S5.004	o	450	R8	9.491	7.424	1.618	Open Manhole	1350
S5.005	o	450	R9	9.471	7.366	1.655	Open Manhole	1350
S5.006	o	450	R10	10.965	7.336	3.179	Open Manhole	1350
S9.000	o	225	R17	9.419	8.369	0.825	Open Manhole	1200
S9.001	o	225	R18	9.420	8.152	1.043	Open Manhole	1200
S9.002	o	225	R19	9.472	8.088	1.159	Open Manhole	1200
S10.000	o	150	R24	9.497	8.447	0.900	Open Manhole	1200
S10.001	o	150	R25	9.469	8.215	1.104	Open Manhole	1200
S9.003	o	225	R20	9.472	8.029	1.218	Open Manhole	1200
S11.000	o	150	R26-HT	9.462	8.322	0.990	Open Manhole	1200
S9.004	o	225	R21	9.449	8.007	1.218	Open Manhole	1200
S9.005	o	300	R22	9.500	7.911	1.289	Open Manhole	1200
S9.006	o	300	R23a	9.489	7.810	1.378	Open Manhole	1200
S9.007	o	300	R23	9.314	7.744	1.270	Open Manhole	1200
S5.007	o	525	R11	9.287	7.119	1.643	Open Manhole	1500

Downstream Manhole

PN	Length (m)	Slope (1:X)	MH Name	C.Level (m)	I.Level (m)	D.Depth (m)	MH Connection	MH DIAM., L*W (mm)
S5.004	28.599	500.0	R9	9.471	7.366	1.655	Open Manhole	1350
S5.005	15.047	500.0	R10	10.965	7.336	3.179	Open Manhole	1350
S5.006	70.902	500.0	R11	9.287	7.194	1.643	Open Manhole	1500
S9.000	32.507	150.0	R18	9.420	8.152	1.043	Open Manhole	1200
S9.001	12.844	200.0	R19	9.472	8.088	1.159	Open Manhole	1200
S9.002	12.961	220.0	R20	9.472	8.029	1.218	Open Manhole	1200
S10.000	34.754	150.0	R25	9.469	8.215	1.104	Open Manhole	1200
S10.001	4.519	150.0	R20	9.472	8.185	1.137	Open Manhole	1200
S9.003	4.944	220.0	R21	9.449	8.007	1.218	Open Manhole	1200
S11.000	7.459	150.0	R21	9.449	8.272	1.027	Open Manhole	1200
S9.004	4.500	220.0	R22	9.500	7.986	1.289	Open Manhole	1200
S9.005	30.279	300.0	R23a	9.489	7.810	1.378	Open Manhole	1200
S9.006	19.977	300.0	R23	9.314	7.744	1.270	Open Manhole	1200
S9.007	31.940	300.0	R11	9.287	7.637	1.350	Open Manhole	1500
S5.007	7.462	500.0	RHW1	7.881	7.105	0.252	Junction	

Doran Consulting Limited		Page 12
Norwood House 96-102 Great Victoria Street Belfast, BT2 7BE		
Date 09/07/2021 12:09 File 202018 - MD - 210611.MDX	Designed by 645 Checked by	
Innovyze		Network 2019.1

PIPELINE SCHEDULES for PR-Storm

Upstream Manhole

PN	Hyd Sect	Diam (mm)	MH Name	C.Level (m)	I.Level (m)	D.Depth (m)	MH Connection	MH DIAM., L*W (mm)
S5.008	o	525	RHW1	7.881	6.989	0.367	Junction	
S12.000	o	225	S55	9.506	8.456	0.825	Open Manhole	1200
S13.000	o	225	60	9.674	8.630	0.819	Open Manhole	1200
S12.001	o	225	SJ2	9.509	8.328	0.956	Junction	
S14.000	o	150	S61	9.478	8.428	0.900	Open Manhole	1200
S12.002	o	375	S56	9.530	8.052	1.103	Open Manhole	1350
S12.003	o	450	S18	9.385	7.831	1.104	Open Manhole	1350
S15.000	o	225	S30	9.503	8.453	0.825	Open Manhole	1200
S12.004	o	450	S20	9.359	7.627	1.282	Open Manhole	1350
S12.005	o	450	S21	9.334	7.573	1.310	Open Manhole	1350
S16.000	o	150	S31	9.485	8.435	0.900	Open Manhole	1200
S12.006	o	525	S22	9.326	7.452	1.349	Open Manhole	1500

Downstream Manhole

PN	Length (m)	Slope (1:X)	MH Name	C.Level (m)	I.Level (m)	D.Depth (m)	MH Connection	MH DIAM., L*W (mm)
S5.008	25.572	9001.0	SHW4-POND	9.300	6.986	1.789	Junction	
S12.000	25.580	200.0	SJ2	9.509	8.328	0.956	Junction	
S13.000	7.000	140.6	SJ2	9.509	8.580	0.704	Junction	
S12.001	14.462	200.0	S56	9.530	8.256	1.049	Open Manhole	1350
S14.000	22.627	150.0	S56	9.530	8.277	1.103	Open Manhole	1350
S12.002	21.952	150.0	S18	9.385	7.906	1.104	Open Manhole	1350
S12.003	61.110	300.0	S20	9.359	7.627	1.282	Open Manhole	1350
S15.000	36.424	150.0	S20	9.359	8.210	0.924	Open Manhole	1350
S12.004	26.885	500.0	S21	9.334	7.573	1.310	Open Manhole	1350
S12.005	23.138	500.0	S22	9.326	7.527	1.349	Open Manhole	1500
S16.000	34.249	150.0	S22	9.326	8.207	0.969	Open Manhole	1500
S12.006	51.492	500.0	S23	9.336	7.349	1.462	Open Manhole	1500

Norwood House  
 96-102 Great Victoria Street  
 Belfast, BT2 7BE



Date 09/07/2021 12:09  
 File 202018 - MD - 210611.MDX

Designed by 645  
 Checked by

Innovyze Network 2019.1

PIPELINE SCHEDULES for PR-Storm

Upstream Manhole

PN	Hyd Sect	Diam (mm)	MH Name	C.Level (m)	I.Level (m)	D.Depth (m)	MH Connection	MH DIAM., L*W (mm)
S17.000	o	225	S32	9.562	8.737	0.600	Open Manhole	1200
S17.001	o	225	S33-3WV	9.651	8.723	0.703	Open Manhole	1200
S12.007	o	525	S23	9.336	7.349	1.462	Open Manhole	1500
S18.000	o	450	S34	10.727	9.077	1.200	Open Manhole	1350
S19.000	o	225	S36	11.000	9.575	1.200	Open Manhole	1200
S18.001	o	450	S35	10.757	7.938	2.369	Open Manhole	1350
S20.000	o	300	S46	9.178	8.053	0.825	Open Manhole	1200
S21.000	o	300	S54	9.378	8.178	0.900	Open Manhole	1200
S20.001	o	375	S48	9.182	7.643	1.164	Open Manhole	1350
S22.000	o	225	S61	9.437	8.312	0.900	Open Manhole	1200
S20.002	o	450	S49	9.180	7.496	1.233	Open Manhole	1350

Downstream Manhole

PN	Length (m)	Slope (1:X)	MH Name	C.Level (m)	I.Level (m)	D.Depth (m)	MH Connection	MH DIAM., L*W (mm)
S17.000	2.783	200.0	S33-3WV	9.651	8.723	0.703	Open Manhole	1200
S17.001	10.482	220.0	S23	9.336	8.675	0.436	Open Manhole	1500
S12.007	16.140	500.0	S24	9.653	7.317	1.811	Open Manhole	1500
S18.000	68.558	60.2	S35	10.757	7.938	2.369	Open Manhole	1350
S19.000	43.007	30.5	S35	10.757	8.163	2.369	Open Manhole	1350
S18.001	44.850	60.0	S24	9.653	7.191	2.012	Open Manhole	1500
S20.000	73.635	220.0	S48	9.182	7.718	1.164	Open Manhole	1350
S21.000	28.863	148.0	S48	9.182	7.983	0.899	Open Manhole	1350
S20.001	25.211	350.0	S49	9.180	7.571	1.233	Open Manhole	1350
S22.000	28.863	200.0	S49	9.180	8.168	0.787	Open Manhole	1350
S20.002	61.203	500.0	S50	9.430	7.374	1.606	Open Manhole	1350

Norwood House  
96-102 Great Victoria Street  
Belfast, BT2 7BE



Date 09/07/2021 12:09  
File 202018 - MD - 210611.MDX

Designed by 645  
Checked by

Innovyze Network 2019.1

PIPELINE SCHEDULES for PR-Storm

Upstream Manhole

PN	Hyd Sect	Diam (mm)	MH Name	C.Level (m)	I.Level (m)	D.Depth (m)	MH Connection	MH DIAM., L*W (mm)
S23.000	o	150	S59	9.323	8.273	0.900	Open Manhole	1200
S20.003	o	450	S50	9.430	7.374	1.606	Open Manhole	1350
S24.000	o	150	S52	9.782	8.732	0.900	Open Manhole	1200
S20.004	o	450	S25	9.627	7.281	1.896	Open Manhole	1350
S12.008	o	600	S24	9.653	7.041	2.012	Open Manhole	1500
S12.009	o	600	SPI2	9.984	7.031	2.354	Open Manhole	1500
S12.010	o	600	S51	9.837	7.020	2.217	Open Manhole	1500
S12.011	o	1200	SHW2	9.300	6.977	1.123	Junction	
S25.000	o	150	39a	9.307	8.307	0.850	Open Manhole	1200
S25.001	o	300	S39	9.335	8.067	0.968	Open Manhole	1200
S25.002	o	300	S40	9.380	7.908	1.173	Open Manhole	1200
S26.000	o	300	S42	9.347	8.147	0.900	Open Manhole	1200
S26.001	o	300	S43	9.417	7.996	1.121	Open Manhole	1200
S26.002	o	300	S44	9.502	7.936	1.266	Open Manhole	1200

Downstream Manhole

PN	Length (m)	Slope (1:X)	MH Name	C.Level (m)	I.Level (m)	D.Depth (m)	MH Connection	MH DIAM., L*W (mm)
S23.000	25.038	150.0	S50	9.430	8.106	1.174	Open Manhole	1350
S20.003	23.736	500.0	S25	9.627	7.326	1.851	Open Manhole	1350
S24.000	9.623	8.4	S25	9.627	7.581	1.896	Open Manhole	1350
S20.004	44.737	500.0	S24	9.653	7.192	2.011	Open Manhole	1500
S12.008	5.134	500.0	SPI2	9.984	7.031	2.354	Open Manhole	1500
S12.009	5.134	500.0	S51	9.837	7.020	2.217	Open Manhole	1500
S12.010	7.371	500.0	SHW2	9.300	7.006	1.694	Junction	
S12.011	149.216	9001.0	SHW4-POND	9.300	6.960	1.140	Junction	
S25.000	13.444	150.0	S39	9.335	8.217	0.968	Open Manhole	1200
S25.001	47.844	300.0	S40	9.380	7.908	1.173	Open Manhole	1200
S25.002	45.119	300.0	S41	9.493	7.757	1.436	Open Manhole	1200
S26.000	45.406	300.0	S43	9.417	7.996	1.121	Open Manhole	1200
S26.001	45.119	300.0	S44	9.502	7.845	1.357	Open Manhole	1200
S26.002	17.573	300.0	S41	9.493	7.877	1.316	Open Manhole	1200

Norwood House  
 96-102 Great Victoria Street  
 Belfast, BT2 7BE



Date 09/07/2021 12:09  
 File 202018 - MD - 210611.MDX

Designed by 645  
 Checked by

Innovyze Network 2019.1

PIPELINE SCHEDULES for PR-Storm

Upstream Manhole

PN	Hyd Sect	Diam (mm)	MH Name	C.Level (m)	I.Level (m)	D.Depth (m)	MH Connection	MH DIAM., L*W (mm)
S25.003	o	300	S41	9.493	7.757	1.436	Open Manhole	1200
S27.000	o	225	S37	9.350	8.122	1.003	Open Manhole	1200
S28.000	o	225	S59	9.314	8.020	1.069	Open Manhole	1200
S27.001	o	300	S53	9.401	7.774	1.327	Open Manhole	1200
S25.004	o	375	S27	9.529	7.414	1.740	Open Manhole	1350
S25.005	o	375	S28	9.579	7.383	1.821	Open Manhole	1350
S25.006	o	375	SPI3	9.566	7.365	1.826	Open Manhole	1350
S25.007	o	375	S29	9.714	7.346	1.994	Open Manhole	1350
S25.008	o	1200	SHW3	9.300	7.169	0.931	Junction	
S1.008	o	600	SHW4-POND	9.300	7.000	1.700	Junction	
S1.009	o	600	S8	9.471	6.957	1.914	Open Manhole	1500
S1.010	o	600	S60	9.630	6.800	2.230	Open Manhole	1500
S29.000	o	375	S57	9.621	7.446	1.800	Open Manhole	1350

Downstream Manhole

PN	Length (m)	Slope (1:X)	MH Name	C.Level (m)	I.Level (m)	D.Depth (m)	MH Connection	MH DIAM., L*W (mm)
S25.003	47.673	177.6	S27	9.529	7.489	1.740	Open Manhole	1350
S27.000	40.942	150.0	S53	9.401	7.849	1.327	Open Manhole	1200
S28.000	15.641	150.0	S53	9.401	7.916	1.261	Open Manhole	1200
S27.001	40.529	150.0	S27	9.529	7.504	1.725	Open Manhole	1350
S25.004	9.176	300.0	S28	9.579	7.383	1.821	Open Manhole	1350
S25.005	5.653	300.0	SPI3	9.566	7.365	1.826	Open Manhole	1350
S25.006	5.653	300.0	S29	9.714	7.346	1.994	Open Manhole	1350
S25.007	6.117	300.0	SHW3	9.300	7.325	1.600	Junction	
S25.008	162.573	9001.0	SHW4-POND	9.300	7.151	0.949	Junction	
S1.008	20.812	500.0	S8	9.471	6.958	1.913	Open Manhole	1500
S1.009	78.294	500.0	S60	9.630	6.800	2.229	Open Manhole	1500
S1.010	70.715	500.0	S9	9.746	6.659	2.488	Open Manhole	1500
S29.000	39.085	300.0	S9	9.746	7.316	2.056	Open Manhole	1500

PIPELINE SCHEDULES for PR-Storm

Upstream Manhole

PN	Hyd Sect	Diam (mm)	MH Name	C.Level (m)	I.Level (m)	D.Depth (m)	MH Connection	MH DIAM., L*W (mm)
S1.011	o	600	S9	9.746	6.651	2.495	Open Manhole	1500
S1.012	o	600	S10-HB	9.642	6.641	2.401	Open Manhole	1500

Downstream Manhole

PN	Length (m)	Slope (1:X)	MH Name	C.Level (m)	I.Level (m)	D.Depth (m)	MH Connection	MH DIAM., L*W (mm)
S1.011	5.855	500.0	S10-HB	9.642	6.639	2.403	Open Manhole	1500
S1.012	33.056	500.0	S-OUT	9.000	6.575	1.825	Open Manhole	0

Free Flowing Outfall Details for PR-Storm

Outfall Pipe Number	Outfall Name	C. Level (m)	I. Level (m)	Min I. Level (m)	D,L (mm)	W (mm)
S1.012	S-OUT	9.000	6.575	0.000	0	0

Simulation Criteria for PR-Storm

Volumetric Runoff Coeff	0.750	Additional Flow - % of Total Flow	0.000
Areal Reduction Factor	1.000	MADD Factor * 10m <sup>3</sup> /ha Storage	2.000
Hot Start (mins)	0	Inlet Coefficient	0.800
Hot Start Level (mm)	0	Flow per Person per Day (l/per/day)	0.000
Manhole Headloss Coeff (Global)	0.500	Run Time (mins)	60
Foul Sewage per hectare (l/s)	0.000	Output Interval (mins)	1
Number of Input Hydrographs	0	Number of Storage Structures	1
Number of Online Controls	1	Number of Time/Area Diagrams	0
Number of Offline Controls	0	Number of Real Time Controls	0

Synthetic Rainfall Details

Rainfall Model	FSR	Profile Type	Summer
Return Period (years)	30	Cv (Summer)	0.750
Region	England and Wales	Cv (Winter)	0.840
M5-60 (mm)	18.000	Storm Duration (mins)	30
Ratio R	0.350		

Doran Consulting Limited		Page 17
Norwood House 96-102 Great Victoria Street Belfast, BT2 7BE		
Date 09/07/2021 12:09 File 202018 - MD - 210611.MDX	Designed by 645 Checked by	
Innovyze		Network 2019.1

Online Controls for PR-Storm

Hydro-Brake® Optimum Manhole: S10-HB, DS/PN: S1.012, Volume (m³): 6.5

Unit Reference	MD-SHE-0219-3340-3000-3340
Design Head (m)	3.000
Design Flow (l/s)	33.4
Flush-Flo™	Calculated
Objective	Minimise upstream storage
Application	Surface
Sump Available	Yes
Diameter (mm)	219
Invert Level (m)	6.641
Minimum Outlet Pipe Diameter (mm)	300
Suggested Manhole Diameter (mm)	2100

Control Points	Head (m)	Flow (l/s)
Design Point (Calculated)	3.000	33.4
Flush-Flo™	0.876	33.4
Kick-Flo®	1.811	26.2
Mean Flow over Head Range	-	29.2

The hydrological calculations have been based on the Head/Discharge relationship for the Hydro-Brake® Optimum as specified. Should another type of control device other than a Hydro-Brake Optimum® be utilised then these storage routing calculations will be invalidated

Depth (m)	Flow (l/s)	Depth (m)	Flow (l/s)	Depth (m)	Flow (l/s)	Depth (m)	Flow (l/s)
0.100	7.4	1.200	32.7	3.000	33.4	7.000	50.2
0.200	21.6	1.400	31.6	3.500	35.9	7.500	51.9
0.300	27.8	1.600	29.7	4.000	38.3	8.000	53.5
0.400	30.1	1.800	26.5	4.500	40.5	8.500	55.1
0.500	31.6	2.000	27.5	5.000	42.7	9.000	56.7
0.600	32.5	2.200	28.7	5.500	44.7	9.500	58.2
0.800	33.3	2.400	30.0	6.000	46.6		
1.000	33.3	2.600	31.1	6.500	48.4		

Doran Consulting Limited		Page 18
Norwood House 96-102 Great Victoria Street Belfast, BT2 7BE		
Date 09/07/2021 12:09 File 202018 - MD - 210611.MDX	Designed by 645 Checked by	
Innovyze	Network 2019.1	

Storage Structures for PR-Storm

Tank or Pond Manhole: SHW4-POND, DS/PN: S1.008

Invert Level (m) 7.000

Depth (m)	Area (m <sup>2</sup> )	Depth (m)	Area (m <sup>2</sup> )
0.000	1724.4	2.200	2140.8



Norwood House  
 96-102 Great Victoria Street  
 Belfast, BT2 7BE



Date 09/07/2021 12:09  
 File 202018 - MD - 210611.MDX

Designed by 645  
 Checked by

Innovyze Network 2019.1

1 year Return Period Summary of Critical Results by Maximum Level (Rank 1)  
 for PR-Storm

Simulation Criteria

Areal Reduction Factor 1.000      Additional Flow - % of Total Flow 0.000  
 Hot Start (mins)                      0                      MADD Factor \* 10m<sup>3</sup>/ha Storage 2.000  
 Hot Start Level (mm)                      0                      Inlet Coefficient 0.800  
 Manhole Headloss Coeff (Global) 0.500      Flow per Person per Day (l/per/day) 0.000  
 Foul Sewage per hectare (l/s) 0.000

Number of Input Hydrographs 0      Number of Storage Structures 1  
 Number of Online Controls 1      Number of Time/Area Diagrams 0  
 Number of Offline Controls 0      Number of Real Time Controls 0

Synthetic Rainfall Details

Rainfall Model                      FSR                      Ratio R 0.350  
 Region England and Wales Cv (Summer) 0.750  
 M5-60 (mm)                      18.000 Cv (Winter) 0.840

Margin for Flood Risk Warning (mm)                      300.0  
 Analysis Timestep 2.5 Second Increment (Extended)  
 DTS Status                      OFF  
 DVD Status                      ON  
 Inertia Status                      ON

Profile(s)                      Summer and Winter  
 Duration(s) (mins) 15, 30, 60, 120, 240, 360, 480, 960, 1440  
 Return Period(s) (years)                      1, 30, 100, 101  
 Climate Change (%)                      0, 0, 0, 20

PN	US/MH Name	Storm	Return Period	Climate Change	First (X) Surchage	First (Y) Flood	First (Z) Overflow	Overflow Act.
S1.000	S4a	15 Winter	1	+0%	101/15 Summer			
S1.001	S4	15 Winter	1	+0%	100/15 Summer			
S1.002	S5a	15 Winter	1	+0%	30/15 Winter			
S2.000	S38	15 Winter	1	+0%	30/15 Summer	101/15 Winter		
S2.001	S16	15 Winter	1	+0%	30/15 Summer			
S1.003	S5	15 Winter	1	+0%	30/15 Summer			
S3.000	S1	15 Winter	1	+0%	30/15 Winter	101/15 Winter		
S3.001	S2	15 Winter	1	+0%	30/15 Summer			
S3.002	S3	15 Winter	1	+0%	30/15 Summer	101/15 Winter		
S3.003	S11	15 Winter	1	+0%	30/15 Summer			
S4.000	S15	60 Winter	1	+0%	100/15 Winter			
S3.004	S12	15 Winter	1	+0%	30/15 Summer			
S3.005	S13	15 Winter	1	+0%	30/15 Summer			
S1.004	S6	15 Winter	1	+0%	30/15 Summer			
S1.005	SPI1	15 Winter	1	+0%	30/15 Summer			
S1.006	S7	15 Winter	1	+0%	30/15 Summer			
S1.007	SHW1	15 Winter	1	+0%	30/15 Summer			
S5.000	R15	15 Winter	1	+0%	30/15 Summer			
S5.001	R16	15 Winter	1	+0%	30/15 Summer			

1 year Return Period Summary of Critical Results by Maximum Level (Rank 1)  
for PR-Storm

PN	US/MH Name	Water	Surcharged	Flooded	Pipe		Level Exceeded	
		Level (m)	Depth (m)	Volume (m <sup>3</sup> )	Flow / Cap.	Overflow (l/s)		Flow (l/s)
S1.000	S4a	8.425	-0.243	0.000	0.08	6.6	OK	
S1.001	S4	8.193	-0.206	0.000	0.21	14.5	OK	
S1.002	S5a	7.990	-0.177	0.000	0.35	24.7	OK	
S2.000	S38	8.004	-0.166	0.000	0.15	6.0	OK	1
S2.001	S16	7.860	-0.130	0.000	0.36	12.0	OK	
S1.003	S5	7.619	-0.106	0.000	0.73	42.4	OK	
S3.000	S1	8.426	-0.152	0.000	0.23	9.2	OK	1
S3.001	S2	8.013	-0.205	0.000	0.21	14.2	OK	
S3.002	S3	7.952	-0.149	0.000	0.41	22.5	OK	
S3.003	S11	7.910	-0.129	0.000	0.60	35.7	OK	
S4.000	S15	8.356	-0.150	0.000	0.00	0.0	OK	
S3.004	S12	7.783	-0.114	0.000	0.70	35.4	OK	
S3.005	S13	7.657	-0.205	0.000	0.40	43.6	OK	
S1.004	S6	7.580	-0.046	0.000	1.00	79.7	OK	
S1.005	SPI1	7.519	-0.085	0.000	1.00	79.6	OK	
S1.006	S7	7.469	-0.112	0.000	0.82	79.6	OK	
S1.007	SHW1	7.450	0.000	0.000	1.22	79.6	OK*	
S5.000	R15	8.474	-0.124	0.000	0.39	13.1	OK	
S5.001	R16	8.271	-0.075	0.000	0.77	21.7	OK	

Norwood House  
 96-102 Great Victoria Street  
 Belfast, BT2 7BE



Date 09/07/2021 12:09  
 File 202018 - MD - 210611.MDX

Designed by 645  
 Checked by

Innovyze Network 2019.1

1 year Return Period Summary of Critical Results by Maximum Level (Rank 1)  
for PR-Storm

PN	US/MH Name	Storm	Return Period	Climate Change	First (X) Surcharge	First (Y) Flood	First (Z) Overflow	Overflow Act.
S6.000	R1	15 Winter	1	+0%	30/15 Summer	101/15 Summer		
S6.001	R2	15 Winter	1	+0%	30/15 Summer	101/15 Winter		
S7.000	R12	15 Winter	1	+0%	100/15 Summer			
S6.002	R3	15 Winter	1	+0%	30/15 Summer			
S6.003	R4	15 Winter	1	+0%	30/15 Summer			
S8.000	R13	15 Winter	1	+0%	30/15 Summer	101/15 Summer		
S8.001	R14	15 Winter	1	+0%	30/15 Summer			
S6.004	R5	15 Winter	1	+0%	30/15 Summer			
S5.002	R6	15 Winter	1	+0%	30/15 Summer			
S5.003	R7	15 Winter	1	+0%	30/15 Summer			
S5.004	R8	15 Winter	1	+0%	30/15 Summer			
S5.005	R9	15 Winter	1	+0%	30/15 Summer			
S5.006	R10	15 Winter	1	+0%	30/15 Summer			
S9.000	R17	15 Winter	1	+0%	30/15 Summer	101/15 Summer		
S9.001	R18	15 Winter	1	+0%	30/15 Summer	101/15 Winter		
S9.002	R19	15 Winter	1	+0%	30/15 Summer			
S10.000	R24	15 Winter	1	+0%	30/15 Summer	100/15 Winter		
S10.001	R25	15 Winter	1	+0%	30/15 Summer			
S9.003	R20	15 Winter	1	+0%	30/15 Summer			
S11.000	R26-HT	60 Winter	1	+0%	30/15 Winter			
S9.004	R21	15 Winter	1	+0%	30/15 Summer			
S9.005	R22	15 Winter	1	+0%	30/15 Summer			
S9.006	R23a	15 Winter	1	+0%	30/15 Summer			
S9.007	R23	15 Winter	1	+0%	30/15 Summer			
S5.007	R11	15 Winter	1	+0%	30/15 Summer			
S5.008	RHW1	15 Winter	1	+0%	30/15 Summer			
S12.000	S55	15 Winter	1	+0%	100/15 Summer	101/15 Winter		
S13.000	60	15 Winter	1	+0%	30/15 Summer	101/15 Winter		
S12.001	SJ2	15 Winter	1	+0%	30/15 Summer			
S14.000	S61	15 Winter	1	+0%	30/15 Winter	101/15 Winter		
S12.002	S56	15 Winter	1	+0%	30/15 Summer			
S12.003	S18	15 Winter	1	+0%	30/15 Summer	101/15 Winter		
S15.000	S30	15 Winter	1	+0%	30/15 Summer	101/15 Winter		
S12.004	S20	15 Winter	1	+0%	30/15 Summer			
S12.005	S21	15 Winter	1	+0%	30/15 Summer			
S16.000	S31	15 Winter	1	+0%	100/15 Winter			
S12.006	S22	15 Winter	1	+0%	30/15 Summer			
S17.000	S32	15 Winter	1	+0%	30/15 Summer			
S17.001	S33-3WV	15 Winter	1	+0%	30/15 Summer			
S12.007	S23	15 Winter	1	+0%	30/15 Summer			
S18.000	S34	15 Winter	1	+0%				
S19.000	S36	15 Winter	1	+0%				
S18.001	S35	15 Winter	1	+0%	100/15 Winter			
S20.000	S46	15 Winter	1	+0%	100/15 Summer	101/15 Winter		
S21.000	S54	15 Winter	1	+0%	100/15 Summer			
S20.001	S48	15 Winter	1	+0%	30/15 Summer			
S22.000	S61	60 Winter	1	+0%	100/15 Winter			
S20.002	S49	15 Winter	1	+0%	30/15 Summer			

1 year Return Period Summary of Critical Results by Maximum Level (Rank 1)  
for PR-Storm

PN	US/MH Name	Water Level (m)	Surcharged Depth (m)	Flooded Volume (m <sup>3</sup> )	Flow / Cap.	Overflow (l/s)	Pipe Flow (l/s)	Status	Level Exceeded
S6.000	R1	8.631	-0.060	0.000	0.66		9.0	OK	4
S6.001	R2	8.413	-0.152	0.000	0.23		8.9	OK	1
S7.000	R12	8.530	-0.145	0.000	0.27		10.2	OK	
S6.002	R3	8.194	-0.191	0.000	0.28		18.9	OK	
S6.003	R4	8.092	-0.177	0.000	0.35		24.0	OK	
S8.000	R13	8.480	-0.069	0.000	0.55		7.7	OK	4
S8.001	R14	8.193	-0.120	0.000	0.44		14.7	OK	
S6.004	R5	7.995	-0.103	0.000	0.75		43.2	OK	
S5.002	R6	7.868	-0.138	0.000	0.66		62.9	OK	
S5.003	R7	7.802	-0.113	0.000	0.83		61.9	OK	
S5.004	R8	7.729	-0.145	0.000	0.58		71.2	OK	
S5.005	R9	7.680	-0.136	0.000	0.82		70.2	OK	
S5.006	R10	7.580	-0.206	0.000	0.54		71.7	OK	
S9.000	R17	8.444	-0.150	0.000	0.24		9.4	OK	4
S9.001	R18	8.287	-0.090	0.000	0.56		17.8	OK	1
S9.002	R19	8.262	-0.051	0.000	0.56		16.9	OK	
S10.000	R24	8.540	-0.057	0.000	0.68		9.5	OK	5
S10.001	R25	8.324	-0.042	0.000	0.86		9.3	OK	
S9.003	R20	8.236	-0.019	0.000	0.99		25.0	OK	
S11.000	R26-HT	8.322	-0.150	0.000	0.00		0.0	OK	
S9.004	R21	8.199	-0.033	0.000	1.00		24.8	OK	
S9.005	R22	8.053	-0.158	0.000	0.43		24.8	OK	
S9.006	R23a	7.997	-0.113	0.000	0.70		38.8	OK	
S9.007	R23	7.923	-0.121	0.000	0.66		38.7	OK	
S5.007	R11	7.476	-0.168	0.000	0.80		108.2	OK	
S5.008	RHW1	7.408	-0.106	0.000	0.99		107.4	OK*	
S12.000	S55	8.510	-0.171	0.000	0.13		4.3	OK	2
S13.000	60	8.745	-0.110	0.000	0.51		15.9	OK	1
S12.001	SJ2	8.448	-0.105	0.000	0.56		20.4	OK*	
S14.000	S61	8.488	-0.090	0.000	0.34		4.6	OK	2
S12.002	S56	8.165	-0.262	0.000	0.20		27.6	OK	
S12.003	S18	8.027	-0.254	0.000	0.38		65.5	OK	1
S15.000	S30	8.561	-0.117	0.000	0.46		18.5	OK	1
S12.004	S20	7.919	-0.158	0.000	0.67		80.9	OK	
S12.005	S21	7.852	-0.171	0.000	0.70		79.7	OK	
S16.000	S31	8.480	-0.105	0.000	0.20		2.8	OK	
S12.006	S22	7.736	-0.241	0.000	0.43		82.7	OK	
S17.000	S32	8.871	-0.091	0.000	0.65		17.7	OK	
S17.001	S33-3WV	8.851	-0.097	0.000	0.61		17.8	OK	
S12.007	S23	7.669	-0.205	0.000	0.68		88.3	OK	
S18.000	S34	9.157	-0.370	0.000	0.07		27.7	OK	
S19.000	S36	9.601	-0.199	0.000	0.03		2.9	OK	
S18.001	S35	8.032	-0.356	0.000	0.10		36.2	OK	
S20.000	S46	8.157	-0.196	0.000	0.24		17.5	OK	1
S21.000	S54	8.311	-0.167	0.000	0.40		32.8	OK	
S20.001	S48	7.841	-0.177	0.000	0.54		49.8	OK	
S22.000	S61	8.312	-0.225	0.000	0.00		0.0	OK	

Norwood House  
 96-102 Great Victoria Street  
 Belfast, BT2 7BE



Date 09/07/2021 12:09  
 File 202018 - MD - 210611.MDX

Designed by 645  
 Checked by

Innovyze Network 2019.1

1 year Return Period Summary of Critical Results by Maximum Level (Rank 1)  
 for PR-Storm

PN	US/MH Name	Water Level (m)	Surcharged Depth (m)	Flooded Volume (m <sup>3</sup> )	Flow / Overflow Cap. (l/s)	Pipe Flow (l/s)	Status	Level Exceeded
S20.002	S49	7.709	-0.237	0.000	0.43	56.4	OK	

Norwood House  
 96-102 Great Victoria Street  
 Belfast, BT2 7BE



Date 09/07/2021 12:09  
 File 202018 - MD - 210611.MDX

Designed by 645  
 Checked by

Innovyze Network 2019.1

1 year Return Period Summary of Critical Results by Maximum Level (Rank 1)  
 for PR-Storm

PN	US/MH Name	Storm	Return Period	Climate Change	First (X) Surcharge	First (Y) Flood	First (Z) Overflow	Overflow Act.
S23.000	S59	15 Winter	1	+0%	100/15 Summer			
S20.003	S50	15 Winter	1	+0%	30/15 Summer			
S24.000	S52	15 Winter	1	+0%				
S20.004	S25	15 Winter	1	+0%	30/15 Summer			
S12.008	S24	15 Winter	1	+0%	30/15 Summer			
S12.009	SPI2	15 Winter	1	+0%	30/15 Summer			
S12.010	S51	15 Winter	1	+0%	30/15 Summer			
S12.011	SHW2	360 Winter	1	+0%				
S25.000	39a	15 Winter	1	+0%	100/15 Summer			
S25.001	S39	15 Winter	1	+0%	100/15 Summer			
S25.002	S40	15 Winter	1	+0%	30/15 Summer			
S26.000	S42	15 Winter	1	+0%	100/15 Summer			
S26.001	S43	15 Winter	1	+0%	30/15 Winter			
S26.002	S44	15 Winter	1	+0%	30/15 Winter			
S25.003	S41	15 Winter	1	+0%	30/15 Summer			
S27.000	S37	15 Winter	1	+0%	101/15 Summer			
S28.000	S59	15 Winter	1	+0%	100/15 Summer			
S27.001	S53	15 Winter	1	+0%	30/15 Winter			
S25.004	S27	15 Winter	1	+0%	30/15 Summer			
S25.005	S28	15 Winter	1	+0%	30/15 Summer			
S25.006	SPI3	15 Winter	1	+0%	30/15 Summer			
S25.007	S29	15 Winter	1	+0%	30/15 Summer			
S25.008	SHW3	15 Winter	1	+0%				
S1.008	SHW4-POND	360 Winter	1	+0%	30/120 Summer			
S1.009	S8	360 Winter	1	+0%	30/60 Winter			
S1.010	S60	360 Winter	1	+0%	30/30 Winter			
S29.000	S57	15 Winter	1	+0%	30/15 Winter			
S1.011	S9	360 Winter	1	+0%	30/15 Summer			
S1.012	S10-HB	360 Winter	1	+0%	30/15 Summer			

PN	US/MH Name	Water Level (m)	Surcharged Depth (m)	Flooded Volume (m <sup>3</sup> )	Pipe Flow / Overflow Cap. (l/s)	Pipe Flow (l/s)	Level Status	Level Exceeded
S23.000	S59	8.339	-0.084	0.000	0.39	5.4	OK	
S20.003	S50	7.604	-0.220	0.000	0.50	58.4	OK	
S24.000	S52	8.764	-0.118	0.000	0.10	5.6	OK	
S20.004	S25	7.536	-0.195	0.000	0.45	58.4	OK	
S12.008	S24	7.485	-0.156	0.000	0.78	167.5	OK	
S12.009	SPI2	7.471	-0.160	0.000	0.78	166.8	OK	
S12.010	S51	7.456	-0.164	0.000	0.91	167.4	OK	
S12.011	SHW2	7.332	-0.845	0.000	0.03	44.7	OK*	
S25.000	39a	8.319	-0.138	0.000	0.02	0.2	OK	
S25.001	S39	8.156	-0.212	0.000	0.18	10.9	OK	
S25.002	S40	8.019	-0.189	0.000	0.28	17.0	OK	
S26.000	S42	8.221	-0.226	0.000	0.13	8.0	OK	
S26.001	S43	8.098	-0.198	0.000	0.22	13.0	OK	

1 year Return Period Summary of Critical Results by Maximum Level (Rank 1)  
for PR-Storm

PN	US/MH Name	Water Level (m)	Surcharged Depth (m)	Flooded Volume (m <sup>3</sup> )	Flow / Overflow Cap. (l/s)	Pipe Flow (l/s)	Status	Level Exceeded
S26.002	S44	8.044	-0.192	0.000	0.28	15.4	OK	
S25.003	S41	7.907	-0.151	0.000	0.49	38.0	OK	
S27.000	S37	8.164	-0.183	0.000	0.08	3.1	OK	
S28.000	S59	8.063	-0.182	0.000	0.08	3.0	OK	
S27.001	S53	7.875	-0.199	0.000	0.24	20.4	OK	
S25.004	S27	7.654	-0.135	0.000	0.65	54.3	OK	
S25.005	S28	7.629	-0.129	0.000	0.75	56.5	OK	
S25.006	SPI3	7.610	-0.130	0.000	0.76	56.7	OK	
S25.007	S29	7.591	-0.130	0.000	0.76	56.6	OK	
S25.008	SHW3	7.331	-1.038	0.000	0.04	56.3	OK*	
S1.008	SHW4-POND	7.328	-0.272	0.000	0.14	39.6	OK*	
S1.009	S8	7.315	-0.242	0.000	0.13	37.4	OK	
S1.010	S60	7.276	-0.124	0.000	0.12	34.0	OK	
S29.000	S57	7.620	-0.201	0.000	0.44	45.6	OK	
S1.011	S9	7.213	-0.038	0.000	0.15	32.4	OK	
S1.012	S10-HB	7.188	-0.053	0.000	0.13	32.1	OK	

Maximum permissible discharge rate 33.4 l/s (QBAR)

30 year Return Period Summary of Critical Results by Maximum Level (Rank 1)  
for PR-Storm

Simulation Criteria

Areal Reduction Factor	1.000	Additional Flow - % of Total Flow	0.000
Hot Start (mins)	0	MADD Factor * 10m <sup>3</sup> /ha Storage	2.000
Hot Start Level (mm)	0	Inlet Coefficient	0.800
Manhole Headloss Coeff (Global)	0.500	Flow per Person per Day (l/per/day)	0.000
Foul Sewage per hectare (l/s)	0.000		

Number of Input Hydrographs	0	Number of Storage Structures	1
Number of Online Controls	1	Number of Time/Area Diagrams	0
Number of Offline Controls	0	Number of Real Time Controls	0

Synthetic Rainfall Details

Rainfall Model	FSR	Ratio R	0.350
Region	England and Wales	Cv (Summer)	0.750
M5-60 (mm)	18.000	Cv (Winter)	0.840

Margin for Flood Risk Warning (mm)	300.0
Analysis Timestep	2.5 Second Increment (Extended)
DTS Status	OFF
DVD Status	ON
Inertia Status	ON

Profile(s)	Summer and Winter
Duration(s) (mins)	15, 30, 60, 120, 240, 360, 480, 960, 1440
Return Period(s) (years)	1, 30, 100, 101
Climate Change (%)	0, 0, 0, 20

PN	US/MH Name	Storm	Return Period	Climate Change	First (X) Surcharge	First (Y) Flood	First (Z) Overflow	Overflow Act.
S1.000	S4a	15 Winter	30	+0%	101/15 Summer			
S1.001	S4	15 Winter	30	+0%	100/15 Summer			
S1.002	S5a	15 Winter	30	+0%	30/15 Winter			
S2.000	S38	15 Winter	30	+0%	30/15 Summer	101/15 Winter		
S2.001	S16	15 Winter	30	+0%	30/15 Summer			
S1.003	S5	15 Winter	30	+0%	30/15 Summer			
S3.000	S1	15 Winter	30	+0%	30/15 Winter	101/15 Winter		
S3.001	S2	15 Winter	30	+0%	30/15 Summer			
S3.002	S3	15 Winter	30	+0%	30/15 Summer	101/15 Winter		
S3.003	S11	15 Winter	30	+0%	30/15 Summer			
S4.000	S15	60 Winter	30	+0%	100/15 Winter			
S3.004	S12	15 Winter	30	+0%	30/15 Summer			
S3.005	S13	15 Winter	30	+0%	30/15 Summer			
S1.004	S6	15 Winter	30	+0%	30/15 Summer			
S1.005	SPI1	480 Winter	30	+0%	30/15 Summer			
S1.006	S7	480 Winter	30	+0%	30/15 Summer			
S1.007	SHW1	120 Winter	30	+0%	30/15 Summer			
S5.000	R15	15 Winter	30	+0%	30/15 Summer			
S5.001	R16	15 Winter	30	+0%	30/15 Summer			



Doran Consulting Limited		Page 27
Norwood House 96-102 Great Victoria Street Belfast, BT2 7BE		
Date 09/07/2021 12:09 File 202018 - MD - 210611.MDX	Designed by 645 Checked by	
Innovyze		Network 2019.1

30 year Return Period Summary of Critical Results by Maximum Level (Rank 1)  
for PR-Storm

PN	US/MH Name	Water		Surcharged		Flooded		Pipe Flow (l/s)	Status	Level Exceeded
		Level (m)	Depth (m)	Volume (m <sup>3</sup> )	Flow / Cap.	Overflow (l/s)				
S1.000	S4a	8.458	-0.210	0.000	0.19		16.1	OK		
S1.001	S4	8.266	-0.133	0.000	0.57		39.9	OK		
S1.002	S5a	8.224	0.057	0.000	0.85		59.5	SURCHARGED		
S2.000	S38	8.260	0.090	0.000	0.34		13.4	SURCHARGED	1	
S2.001	S16	8.234	0.245	0.000	0.72		24.1	SURCHARGED		
S1.003	S5	8.122	0.397	0.000	1.44		83.4	SURCHARGED		
S3.000	S1	8.601	0.023	0.000	0.51		20.6	SURCHARGED	1	
S3.001	S2	8.536	0.318	0.000	0.44		29.5	SURCHARGED		
S3.002	S3	8.452	0.351	0.000	0.76		41.9	SURCHARGED		
S3.003	S11	8.386	0.347	0.000	1.31		78.2	SURCHARGED		
S4.000	S15	8.356	-0.150	0.000	0.00		0.0	OK		
S3.004	S12	8.170	0.274	0.000	1.50		75.5	SURCHARGED		
S3.005	S13	8.086	0.225	0.000	0.88		95.2	SURCHARGED		
S1.004	S6	7.917	0.291	0.000	2.40		191.7	SURCHARGED		
S1.005	SPI1	7.809	0.205	0.000	0.46		36.9	SURCHARGED		
S1.006	S7	7.808	0.226	0.000	0.38		37.0	SURCHARGED		
S1.007	SHW1	7.567	0.117	0.000	1.53		100.1	SURCHARGED*		
S5.000	R15	8.680	0.082	0.000	0.92		31.0	SURCHARGED		
S5.001	R16	8.452	0.106	0.000	1.93		54.6	SURCHARGED		

Norwood House  
 96-102 Great Victoria Street  
 Belfast, BT2 7BE



Date 09/07/2021 12:09  
 File 202018 - MD - 210611.MDX

Designed by 645  
 Checked by

Innovyze Network 2019.1

30 year Return Period Summary of Critical Results by Maximum Level (Rank 1)  
for PR-Storm

PN	US/MH Name	Storm	Return Period	Climate Change	First (X) Surchage	First (Y) Flood	First (Z) Overflow	Overflow Act.
S6.000	R1	15 Winter	30	+0%	30/15 Summer	101/15 Summer		
S6.001	R2	15 Winter	30	+0%	30/15 Summer	101/15 Winter		
S7.000	R12	15 Winter	30	+0%	100/15 Summer			
S6.002	R3	15 Winter	30	+0%	30/15 Summer			
S6.003	R4	15 Winter	30	+0%	30/15 Summer			
S8.000	R13	15 Winter	30	+0%	30/15 Summer	101/15 Summer		
S8.001	R14	15 Winter	30	+0%	30/15 Summer			
S6.004	R5	15 Winter	30	+0%	30/15 Summer			
S5.002	R6	15 Winter	30	+0%	30/15 Summer			
S5.003	R7	15 Winter	30	+0%	30/15 Summer			
S5.004	R8	15 Winter	30	+0%	30/15 Summer			
S5.005	R9	15 Winter	30	+0%	30/15 Summer			
S5.006	R10	15 Winter	30	+0%	30/15 Summer			
S9.000	R17	15 Winter	30	+0%	30/15 Summer	101/15 Summer		
S9.001	R18	15 Winter	30	+0%	30/15 Summer	101/15 Winter		
S9.002	R19	15 Winter	30	+0%	30/15 Summer			
S10.000	R24	15 Winter	30	+0%	30/15 Summer	100/15 Winter		
S10.001	R25	15 Winter	30	+0%	30/15 Summer			
S9.003	R20	15 Winter	30	+0%	30/15 Summer			
S11.000	R26-HT	15 Winter	30	+0%	30/15 Winter			
S9.004	R21	15 Winter	30	+0%	30/15 Summer			
S9.005	R22	15 Winter	30	+0%	30/15 Summer			
S9.006	R23a	15 Winter	30	+0%	30/15 Summer			
S9.007	R23	15 Winter	30	+0%	30/15 Summer			
S5.007	R11	480 Winter	30	+0%	30/15 Summer			
S5.008	RHW1	120 Winter	30	+0%	30/15 Summer			
S12.000	S55	15 Winter	30	+0%	100/15 Summer	101/15 Winter		
S13.000	60	15 Winter	30	+0%	30/15 Summer	101/15 Winter		
S12.001	SJ2	15 Winter	30	+0%	30/15 Summer			
S14.000	S61	15 Winter	30	+0%	30/15 Winter	101/15 Winter		
S12.002	S56	15 Winter	30	+0%	30/15 Summer			
S12.003	S18	15 Winter	30	+0%	30/15 Summer	101/15 Winter		
S15.000	S30	15 Winter	30	+0%	30/15 Summer	101/15 Winter		
S12.004	S20	15 Winter	30	+0%	30/15 Summer			
S12.005	S21	15 Winter	30	+0%	30/15 Summer			
S16.000	S31	15 Winter	30	+0%	100/15 Winter			
S12.006	S22	15 Winter	30	+0%	30/15 Summer			
S17.000	S32	15 Winter	30	+0%	30/15 Summer			
S17.001	S33-3WV	15 Winter	30	+0%	30/15 Summer			
S12.007	S23	15 Winter	30	+0%	30/15 Summer			
S18.000	S34	15 Winter	30	+0%				
S19.000	S36	15 Winter	30	+0%				
S18.001	S35	15 Winter	30	+0%	100/15 Winter			
S20.000	S46	15 Winter	30	+0%	100/15 Summer	101/15 Winter		
S21.000	S54	15 Winter	30	+0%	100/15 Summer			
S20.001	S48	15 Winter	30	+0%	30/15 Summer			
S22.000	S61	60 Winter	30	+0%	100/15 Winter			
S20.002	S49	15 Winter	30	+0%	30/15 Summer			

30 year Return Period Summary of Critical Results by Maximum Level (Rank 1)  
for PR-Storm

PN	US/MH Name	Water Level (m)	Surcharged Depth (m)	Flooded Volume (m <sup>3</sup> )	Flow / Cap. (l/s)	Overflow (l/s)	Pipe Flow (l/s)	Status	Level Exceeded
S6.000	R1	8.862	0.171	0.000	1.52		20.5	SURCHARGED	4
S6.001	R2	8.673	0.108	0.000	0.45		17.5	SURCHARGED	1
S7.000	R12	8.668	-0.007	0.000	0.66		25.0	OK	
S6.002	R3	8.629	0.243	0.000	0.50		33.7	SURCHARGED	
S6.003	R4	8.544	0.275	0.000	0.59		40.8	SURCHARGED	
S8.000	R13	8.759	0.210	0.000	1.14		15.9	SURCHARGED	4
S8.001	R14	8.531	0.217	0.000	0.98		32.6	SURCHARGED	
S6.004	R5	8.458	0.359	0.000	1.38		79.3	SURCHARGED	
S5.002	R6	8.294	0.288	0.000	1.35		127.8	SURCHARGED	
S5.003	R7	8.131	0.217	0.000	1.70		127.3	SURCHARGED	
S5.004	R8	8.028	0.154	0.000	1.25		152.9	SURCHARGED	
S5.005	R9	7.933	0.117	0.000	1.79		152.6	SURCHARGED	
S5.006	R10	7.874	0.088	0.000	1.16		155.0	SURCHARGED	
S9.000	R17	8.834	0.240	0.000	0.46		18.1	SURCHARGED	4
S9.001	R18	8.787	0.410	0.000	1.20		37.9	SURCHARGED	1
S9.002	R19	8.707	0.394	0.000	1.19		36.0	SURCHARGED	
S10.000	R24	9.057	0.460	0.000	1.22		17.0	SURCHARGED	5
S10.001	R25	8.697	0.331	0.000	1.67		18.1	SURCHARGED	
S9.003	R20	8.624	0.370	0.000	2.07		52.4	SURCHARGED	
S11.000	R26-HT	8.486	0.014	0.000	0.08		1.0	SURCHARGED	
S9.004	R21	8.486	0.254	0.000	2.15		53.4	SURCHARGED	
S9.005	R22	8.367	0.156	0.000	0.92		53.6	SURCHARGED	
S9.006	R23a	8.287	0.176	0.000	1.46		81.1	SURCHARGED	
S9.007	R23	8.132	0.088	0.000	1.39		81.2	SURCHARGED	
S5.007	R11	7.808	0.163	0.000	0.38		51.5	SURCHARGED	
S5.008	RHW1	7.630	0.116	0.000	1.26		136.4	FLOOD RISK*	
S12.000	S55	8.648	-0.033	0.000	0.28		9.5	OK	2
S13.000	60	8.876	0.021	0.000	1.24		39.0	SURCHARGED	1
S12.001	SJ2	8.627	0.073	0.000	1.29		47.3	SURCHARGED*	
S14.000	S61	8.595	0.017	0.000	0.80		11.0	SURCHARGED	2
S12.002	S56	8.548	0.121	0.000	0.42		58.4	SURCHARGED	
S12.003	S18	8.454	0.173	0.000	0.89		152.0	SURCHARGED	1
S15.000	S30	8.713	0.035	0.000	1.08		43.1	SURCHARGED	1
S12.004	S20	8.377	0.300	0.000	1.64		199.2	SURCHARGED	
S12.005	S21	8.293	0.270	0.000	1.68		191.9	SURCHARGED	
S16.000	S31	8.509	-0.076	0.000	0.48		6.8	OK	
S12.006	S22	8.207	0.230	0.000	0.99		191.8	SURCHARGED	
S17.000	S32	9.089	0.127	0.000	1.57		42.8	SURCHARGED	
S17.001	S33-3WV	8.993	0.045	0.000	1.46		42.8	SURCHARGED	
S12.007	S23	8.110	0.236	0.000	1.68		216.7	SURCHARGED	
S18.000	S34	9.205	-0.322	0.000	0.17		67.5	OK	
S19.000	S36	9.617	-0.183	0.000	0.08		7.0	OK	
S18.001	S35	8.089	-0.299	0.000	0.24		90.5	OK	
S20.000	S46	8.312	-0.041	0.000	0.60		43.0	OK	1
S21.000	S54	8.417	-0.061	0.000	0.97		79.8	OK	
S20.001	S48	8.267	0.248	0.000	1.23		113.0	SURCHARGED	
S22.000	S61	8.312	-0.225	0.000	0.00		0.0	OK	

Norwood House  
 96-102 Great Victoria Street  
 Belfast, BT2 7BE



Date 09/07/2021 12:09  
 File 202018 - MD - 210611.MDX

Designed by 645  
 Checked by

Innovyze

Network 2019.1

30 year Return Period Summary of Critical Results by Maximum Level (Rank 1)  
 for PR-Storm

PN	US/MH Name	Water Level (m)	Surcharged Depth (m)	Flooded Volume (m <sup>3</sup> )	Flow / Cap. (l/s)	Overflow (l/s)	Pipe Flow (l/s)	Status	Level Exceeded
S20.002	S49	8.208	0.261	0.000	0.90		118.8	SURCHARGED	

30 year Return Period Summary of Critical Results by Maximum Level (Rank 1)  
for PR-Storm

PN	US/MH Name	Storm	Return Period	Climate Change	First (X) Surcharge	First (Y) Flood	First (Z) Overflow	Overflow Act.
S23.000	S59	15 Winter	30	+0%	100/15 Summer			
S20.003	S50	15 Winter	30	+0%	30/15 Summer			
S24.000	S52	15 Winter	30	+0%				
S20.004	S25	15 Winter	30	+0%	30/15 Summer			
S12.008	S24	15 Winter	30	+0%	30/15 Summer			
S12.009	SPI2	15 Winter	30	+0%	30/15 Summer			
S12.010	S51	360 Winter	30	+0%	30/15 Summer			
S12.011	SHW2	360 Winter	30	+0%				
S25.000	39a	15 Winter	30	+0%	100/15 Summer			
S25.001	S39	15 Winter	30	+0%	100/15 Summer			
S25.002	S40	15 Winter	30	+0%	30/15 Summer			
S26.000	S42	15 Winter	30	+0%	100/15 Summer			
S26.001	S43	15 Winter	30	+0%	30/15 Winter			
S26.002	S44	15 Winter	30	+0%	30/15 Winter			
S25.003	S41	15 Winter	30	+0%	30/15 Summer			
S27.000	S37	15 Winter	30	+0%	101/15 Summer			
S28.000	S59	15 Winter	30	+0%	100/15 Summer			
S27.001	S53	15 Winter	30	+0%	30/15 Winter			
S25.004	S27	15 Winter	30	+0%	30/15 Summer			
S25.005	S28	15 Winter	30	+0%	30/15 Summer			
S25.006	SPI3	15 Winter	30	+0%	30/15 Summer			
S25.007	S29	480 Winter	30	+0%	30/15 Summer			
S25.008	SHW3	480 Winter	30	+0%				
S1.008	SHW4-POND	480 Winter	30	+0%	30/120 Summer			
S1.009	S8	480 Winter	30	+0%	30/60 Winter			
S1.010	S60	360 Winter	30	+0%	30/30 Winter			
S29.000	S57	360 Winter	30	+0%	30/15 Winter			
S1.011	S9	360 Winter	30	+0%	30/15 Summer			
S1.012	S10-HB	360 Winter	30	+0%	30/15 Summer			

PN	US/MH Name	Water Level (m)	Surcharged Depth (m)	Flooded Volume (m³)	Flow / Cap.	Overflow (l/s)	Pipe Flow (l/s)	Status	Level Exceeded
S23.000	S59	8.391	-0.032	0.000	0.97		13.3	OK	
S20.003	S50	8.168	0.344	0.000	1.02		118.7	SURCHARGED	
S24.000	S52	8.783	-0.099	0.000	0.25		13.8	OK	
S20.004	S25	8.126	0.395	0.000	0.91		117.0	SURCHARGED	
S12.008	S24	8.049	0.408	0.000	1.85		397.6	SURCHARGED	
S12.009	SPI2	7.888	0.258	0.000	1.85		395.9	SURCHARGED	
S12.010	S51	7.819	0.199	0.000	0.51		92.9	SURCHARGED	
S12.011	SHW2	7.817	-0.360	0.000	0.07		92.2	OK*	
S25.000	39a	8.329	-0.128	0.000	0.04		0.6	OK	
S25.001	S39	8.327	-0.040	0.000	0.54		32.4	OK	
S25.002	S40	8.285	0.077	0.000	0.70		41.6	SURCHARGED	
S26.000	S42	8.330	-0.117	0.000	0.32		19.3	OK	
S26.001	S43	8.308	0.012	0.000	0.49		29.4	SURCHARGED	

30 year Return Period Summary of Critical Results by Maximum Level (Rank 1)  
for PR-Storm

PN	US/MH Name	Water Level (m)	Surcharged Depth (m)	Flooded Volume (m <sup>3</sup> )	Flow / Cap. (l/s)	Overflow (l/s)	Pipe Flow (l/s)	Status	Level Exceeded
S26.002	S44	8.249	0.013	0.000	0.60		32.7	SURCHARGED	
S25.003	S41	8.214	0.156	0.000	0.89		69.3	SURCHARGED	
S27.000	S37	8.189	-0.158	0.000	0.19		7.6	OK	
S28.000	S59	8.105	-0.140	0.000	0.20		7.4	OK	
S27.001	S53	8.094	0.020	0.000	0.66		55.3	SURCHARGED	
S25.004	S27	7.990	0.201	0.000	1.28		106.6	SURCHARGED	
S25.005	S28	7.930	0.172	0.000	1.50		112.4	SURCHARGED	
S25.006	SPI3	7.848	0.108	0.000	1.49		112.0	SURCHARGED	
S25.007	S29	7.806	0.085	0.000	0.31		23.5	SURCHARGED	
S25.008	SHW3	7.805	-0.564	0.000	0.02		23.2	OK*	
S1.008	SHW4-POND	7.805	0.205	0.000	0.59		165.0	SURCHARGED*	
S1.009	S8	8.034	0.477	0.000	0.44		122.7	SURCHARGED	
S1.010	S60	8.190	0.790	0.000	0.34		94.8	SURCHARGED	
S29.000	S57	8.228	0.407	0.000	0.41		43.1	SURCHARGED	
S1.011	S9	8.223	0.972	0.000	0.23		48.3	SURCHARGED	
S1.012	S10-HB	8.222	0.981	0.000	0.13		33.4	SURCHARGED	

**Maximum permissible discharge rate 33.4 l/s (QBAR)**

100 year Return Period Summary of Critical Results by Maximum Level (Rank 1) for PR-Storm

Simulation Criteria

Areal Reduction Factor	1.000	Additional Flow - % of Total Flow	0.000
Hot Start (mins)	0	MADD Factor * 10m <sup>3</sup> /ha Storage	2.000
Hot Start Level (mm)	0	Inlet Coefficient	0.800
Manhole Headloss Coeff (Global)	0.500	Flow per Person per Day (l/per/day)	0.000
Foul Sewage per hectare (l/s)	0.000		

Number of Input Hydrographs	0	Number of Storage Structures	1
Number of Online Controls	1	Number of Time/Area Diagrams	0
Number of Offline Controls	0	Number of Real Time Controls	0

Synthetic Rainfall Details

Rainfall Model	FSR	Ratio R	0.350
Region	England and Wales	Cv (Summer)	0.750
M5-60 (mm)	18.000	Cv (Winter)	0.840

Margin for Flood Risk Warning (mm)	300.0
Analysis Timestep	2.5 Second Increment (Extended)
DTS Status	OFF
DVD Status	ON
Inertia Status	ON

Profile(s)	Summer and Winter
Duration(s) (mins)	15, 30, 60, 120, 240, 360, 480, 960, 1440
Return Period(s) (years)	1, 30, 100, 101
Climate Change (%)	0, 0, 0, 20

PN	US/MH Name	Storm	Return Period	Climate Change	First (X) Surcharge	First (Y) Flood	First (Z) Overflow	Overflow Act.
S1.000	S4a	15 Winter	100	+0%	101/15 Summer			
S1.001	S4	15 Winter	100	+0%	100/15 Summer			
S1.002	S5a	15 Winter	100	+0%	30/15 Winter			
S2.000	S38	15 Winter	100	+0%	30/15 Summer	101/15 Winter		
S2.001	S16	15 Winter	100	+0%	30/15 Summer			
S1.003	S5	15 Winter	100	+0%	30/15 Summer			
S3.000	S1	15 Winter	100	+0%	30/15 Winter	101/15 Winter		
S3.001	S2	15 Winter	100	+0%	30/15 Summer			
S3.002	S3	15 Winter	100	+0%	30/15 Summer	101/15 Winter		
S3.003	S11	15 Winter	100	+0%	30/15 Summer			
S4.000	S15	15 Winter	100	+0%	100/15 Winter			
S3.004	S12	15 Winter	100	+0%	30/15 Summer			
S3.005	S13	15 Winter	100	+0%	30/15 Summer			
S1.004	S6	15 Winter	100	+0%	30/15 Summer			
S1.005	SPI1	480 Winter	100	+0%	30/15 Summer			
S1.006	S7	480 Winter	100	+0%	30/15 Summer			
S1.007	SHW1	60 Winter	100	+0%	30/15 Summer			
S5.000	R15	15 Winter	100	+0%	30/15 Summer			
S5.001	R16	15 Winter	100	+0%	30/15 Summer			

100 year Return Period Summary of Critical Results by Maximum Level (Rank 1) for PR-Storm

PN	US/MH Name	Water		Surcharged		Flooded		Pipe Flow (l/s)	Status	Level Exceeded
		Level (m)	Depth (m)	Volume (m³)	Flow / Cap. (l/s)	Overflow (l/s)				
S1.000	S4a	8.668	0.000	0.000	0.24		20.4	OK		
S1.001	S4	8.636	0.237	0.000	0.65		45.5	SURCHARGED		
S1.002	S5a	8.551	0.384	0.000	0.87		60.6	SURCHARGED		
S2.000	S38	8.651	0.481	0.000	0.37		14.4	SURCHARGED	1	
S2.001	S16	8.618	0.628	0.000	0.84		28.4	SURCHARGED		
S1.003	S5	8.417	0.692	0.000	1.71		98.8	SURCHARGED		
S3.000	S1	9.130	0.552	0.000	0.54		22.2	SURCHARGED	1	
S3.001	S2	9.013	0.795	0.000	0.49		32.5	SURCHARGED		
S3.002	S3	8.931	0.829	0.000	0.96		52.9	SURCHARGED		
S3.003	S11	8.866	0.827	0.000	1.56		92.6	SURCHARGED		
S4.000	S15	8.506	0.000	0.000	0.11		1.4	SURCHARGED		
S3.004	S12	8.513	0.617	0.000	1.83		92.3	SURCHARGED		
S3.005	S13	8.382	0.521	0.000	1.08		116.9	SURCHARGED		
S1.004	S6	8.126	0.500	0.000	2.94		234.6	SURCHARGED		
S1.005	SPI1	8.094	0.490	0.000	0.60		47.7	SURCHARGED		
S1.006	S7	8.092	0.510	0.000	0.49		47.4	SURCHARGED		
S1.007	SHW1	7.567	0.117	0.000	2.71		176.6	SURCHARGED*		
S5.000	R15	9.026	0.428	0.000	1.05		35.3	SURCHARGED		
S5.001	R16	8.791	0.445	0.000	2.24		63.3	SURCHARGED		



Norwood House  
 96-102 Great Victoria Street  
 Belfast, BT2 7BE



Date 09/07/2021 12:09  
 File 202018 - MD - 210611.MDX

Designed by 645  
 Checked by

Innovyze

Network 2019.1

100 year Return Period Summary of Critical Results by Maximum Level (Rank 1) for PR-Storm

PN	US/MH Name	Storm	Return Period	Climate Change	First (X) Surchage	First (Y) Flood	First (Z) Overflow	Overflow Act.
S6.000	R1	15 Winter	100	+0%	30/15 Summer	101/15 Summer		
S6.001	R2	15 Winter	100	+0%	30/15 Summer	101/15 Winter		
S7.000	R12	15 Winter	100	+0%	100/15 Summer			
S6.002	R3	15 Winter	100	+0%	30/15 Summer			
S6.003	R4	15 Winter	100	+0%	30/15 Summer			
S8.000	R13	15 Winter	100	+0%	30/15 Summer	101/15 Summer		
S8.001	R14	15 Winter	100	+0%	30/15 Summer			
S6.004	R5	15 Winter	100	+0%	30/15 Summer			
S5.002	R6	15 Winter	100	+0%	30/15 Summer			
S5.003	R7	15 Winter	100	+0%	30/15 Summer			
S5.004	R8	15 Winter	100	+0%	30/15 Summer			
S5.005	R9	15 Winter	100	+0%	30/15 Summer			
S5.006	R10	480 Winter	100	+0%	30/15 Summer			
S9.000	R17	15 Winter	100	+0%	30/15 Summer	101/15 Summer		
S9.001	R18	15 Winter	100	+0%	30/15 Summer	101/15 Winter		
S9.002	R19	15 Winter	100	+0%	30/15 Summer			
S10.000	R24	15 Winter	100	+0%	30/15 Summer	100/15 Winter		
S10.001	R25	15 Winter	100	+0%	30/15 Summer			
S9.003	R20	15 Winter	100	+0%	30/15 Summer			
S11.000	R26-HT	15 Winter	100	+0%	30/15 Winter			
S9.004	R21	15 Winter	100	+0%	30/15 Summer			
S9.005	R22	15 Winter	100	+0%	30/15 Summer			
S9.006	R23a	15 Winter	100	+0%	30/15 Summer			
S9.007	R23	15 Winter	100	+0%	30/15 Summer			
S5.007	R11	480 Winter	100	+0%	30/15 Summer			
S5.008	RHW1	60 Winter	100	+0%	30/15 Summer			
S12.000	S55	15 Winter	100	+0%	100/15 Summer	101/15 Winter		
S13.000	60	15 Winter	100	+0%	30/15 Summer	101/15 Winter		
S12.001	SJ2	15 Winter	100	+0%	30/15 Summer			
S14.000	S61	15 Winter	100	+0%	30/15 Winter	101/15 Winter		
S12.002	S56	15 Winter	100	+0%	30/15 Summer			
S12.003	S18	15 Winter	100	+0%	30/15 Summer	101/15 Winter		
S15.000	S30	15 Winter	100	+0%	30/15 Summer	101/15 Winter		
S12.004	S20	15 Winter	100	+0%	30/15 Summer			
S12.005	S21	15 Winter	100	+0%	30/15 Summer			
S16.000	S31	15 Winter	100	+0%	100/15 Winter			
S12.006	S22	15 Winter	100	+0%	30/15 Summer			
S17.000	S32	15 Winter	100	+0%	30/15 Summer			
S17.001	S33-3WV	15 Winter	100	+0%	30/15 Summer			
S12.007	S23	15 Winter	100	+0%	30/15 Summer			
S18.000	S34	15 Winter	100	+0%				
S19.000	S36	15 Winter	100	+0%				
S18.001	S35	15 Winter	100	+0%	100/15 Winter			
S20.000	S46	15 Winter	100	+0%	100/15 Summer	101/15 Winter		
S21.000	S54	15 Winter	100	+0%	100/15 Summer			
S20.001	S48	15 Winter	100	+0%	30/15 Summer			
S22.000	S61	15 Winter	100	+0%	100/15 Winter			
S20.002	S49	15 Winter	100	+0%	30/15 Summer			

100 year Return Period Summary of Critical Results by Maximum Level (Rank 1) for PR-Storm

PN	US/MH Name	Water Level (m)	Surcharged Depth (m)	Flooded Volume (m <sup>3</sup> )	Flow / Cap. (l/s)	Overflow (l/s)	Pipe Flow (l/s)	Status	Level Exceeded
S6.000	R1	9.327	0.636	0.000	1.66		22.5	FLOOD RISK	4
S6.001	R2	9.084	0.519	0.000	0.49		19.1	SURCHARGED	1
S7.000	R12	9.115	0.440	0.000	0.75		28.7	SURCHARGED	
S6.002	R3	9.047	0.661	0.000	0.60		40.2	SURCHARGED	
S6.003	R4	8.961	0.693	0.000	0.71		49.2	SURCHARGED	
S8.000	R13	9.243	0.694	0.000	1.19		16.6	FLOOD RISK	4
S8.001	R14	8.939	0.626	0.000	1.10		36.6	SURCHARGED	
S6.004	R5	8.873	0.775	0.000	1.54		88.5	SURCHARGED	
S5.002	R6	8.646	0.640	0.000	1.50		142.3	SURCHARGED	
S5.003	R7	8.443	0.528	0.000	1.91		142.5	SURCHARGED	
S5.004	R8	8.313	0.439	0.000	1.45		178.1	SURCHARGED	
S5.005	R9	8.189	0.372	0.000	2.08		177.1	SURCHARGED	
S5.006	R10	8.096	0.309	0.000	0.30		39.6	SURCHARGED	
S9.000	R17	9.229	0.635	0.000	0.56		22.1	FLOOD RISK	4
S9.001	R18	9.163	0.786	0.000	1.42		45.0	FLOOD RISK	1
S9.002	R19	9.040	0.727	0.000	1.44		43.6	SURCHARGED	
S10.000	R24	9.497	0.900	0.074	1.43		19.9	FLOOD	5
S10.001	R25	9.019	0.654	0.000	1.95		21.2	SURCHARGED	
S9.003	R20	8.920	0.666	0.000	2.47		62.6	SURCHARGED	
S11.000	R26-HT	8.724	0.252	0.000	0.15		1.9	SURCHARGED	
S9.004	R21	8.727	0.495	0.000	2.59		64.3	SURCHARGED	
S9.005	R22	8.542	0.331	0.000	1.11		64.3	SURCHARGED	
S9.006	R23a	8.457	0.347	0.000	1.77		98.5	SURCHARGED	
S9.007	R23	8.230	0.187	0.000	1.68		97.7	SURCHARGED	
S5.007	R11	8.092	0.448	0.000	0.46		62.6	SURCHARGED	
S5.008	RHW1	7.630	0.116	0.000	2.29		248.5	FLOOD RISK*	
S12.000	S55	9.182	0.501	0.000	0.27		9.0	SURCHARGED	2
S13.000	60	9.242	0.387	0.000	1.53		48.1	SURCHARGED	1
S12.001	SJ2	8.805	0.252	0.000	1.34		49.1	SURCHARGED*	
S14.000	S61	9.138	0.560	0.000	0.87		11.9	SURCHARGED	2
S12.002	S56	9.097	0.670	0.000	0.45		62.6	SURCHARGED	
S12.003	S18	8.983	0.702	0.000	1.09		186.7	SURCHARGED	1
S15.000	S30	9.063	0.385	0.000	1.32		52.8	SURCHARGED	1
S12.004	S20	8.843	0.766	0.000	1.87		227.5	SURCHARGED	
S12.005	S21	8.702	0.678	0.000	1.89		216.8	SURCHARGED	
S16.000	S31	8.588	0.003	0.000	0.62		8.7	SURCHARGED	
S12.006	S22	8.560	0.583	0.000	1.16		223.6	SURCHARGED	
S17.000	S32	9.208	0.246	0.000	1.99		54.4	SURCHARGED	
S17.001	S33-3WV	9.055	0.107	0.000	1.85		54.3	SURCHARGED	
S12.007	S23	8.420	0.546	0.000	2.07		267.5	SURCHARGED	
S18.000	S34	9.223	-0.304	0.000	0.22		87.0	OK	
S19.000	S36	9.623	-0.177	0.000	0.10		9.1	OK	
S18.001	S35	8.484	0.096	0.000	0.31		115.2	SURCHARGED	
S20.000	S46	8.744	0.391	0.000	0.70		49.8	SURCHARGED	1
S21.000	S54	8.780	0.302	0.000	1.21		100.2	SURCHARGED	
S20.001	S48	8.648	0.630	0.000	1.28		117.4	SURCHARGED	
S22.000	S61	8.566	0.029	0.000	0.04		1.3	SURCHARGED	

Doran Consulting Limited		Page 37
Norwood House 96-102 Great Victoria Street Belfast, BT2 7BE		
Date 09/07/2021 12:09 File 202018 - MD - 210611.MDX	Designed by 645 Checked by	
Innovyze		Network 2019.1

100 year Return Period Summary of Critical Results by Maximum Level (Rank 1) for PR-Storm

PN	US/MH Name	Water Surcharged			Flooded		Pipe	Status	Level Exceeded
		Level (m)	Depth (m)	Volume (m <sup>3</sup> )	Flow / Cap.	Overflow (l/s)	Flow (l/s)		
S20.002	S49	8.566	0.620	0.000	0.95		125.3	SURCHARGED	

100 year Return Period Summary of Critical Results by Maximum Level (Rank 1) for PR-Storm

PN	US/MH Name	Storm	Return Period	Climate Change	First (X) Surcharge	First (Y) Flood	First (Z) Overflow	Overflow Act.
S23.000	S59	15 Winter	100	+0%	100/15 Summer			
S20.003	S50	15 Winter	100	+0%	30/15 Summer			
S24.000	S52	15 Winter	100	+0%				
S20.004	S25	15 Winter	100	+0%	30/15 Summer			
S12.008	S24	15 Winter	100	+0%	30/15 Summer			
S12.009	SPI2	480 Winter	100	+0%	30/15 Summer			
S12.010	S51	480 Winter	100	+0%	30/15 Summer			
S12.011	SHW2	480 Winter	100	+0%				
S25.000	39a	15 Winter	100	+0%	100/15 Summer			
S25.001	S39	15 Winter	100	+0%	100/15 Summer			
S25.002	S40	15 Winter	100	+0%	30/15 Summer			
S26.000	S42	15 Winter	100	+0%	100/15 Summer			
S26.001	S43	15 Winter	100	+0%	30/15 Winter			
S26.002	S44	15 Winter	100	+0%	30/15 Winter			
S25.003	S41	15 Winter	100	+0%	30/15 Summer			
S27.000	S37	15 Winter	100	+0%	101/15 Summer			
S28.000	S59	15 Winter	100	+0%	100/15 Summer			
S27.001	S53	15 Winter	100	+0%	30/15 Winter			
S25.004	S27	15 Winter	100	+0%	30/15 Summer			
S25.005	S28	480 Winter	100	+0%	30/15 Summer			
S25.006	SPI3	480 Winter	100	+0%	30/15 Summer			
S25.007	S29	480 Winter	100	+0%	30/15 Summer			
S25.008	SHW3	480 Winter	100	+0%				
S1.008	SHW4-POND	480 Winter	100	+0%	30/120 Summer			
S1.009	S8	360 Winter	100	+0%	30/60 Winter			
S1.010	S60	360 Winter	100	+0%	30/30 Winter			
S29.000	S57	360 Winter	100	+0%	30/15 Winter			
S1.011	S9	360 Winter	100	+0%	30/15 Summer			
S1.012	S10-HB	360 Winter	100	+0%	30/15 Summer			

PN	US/MH Name	Water Level (m)	Surcharged Depth (m)	Flooded Volume (m³)	Flow / Cap. (l/s)	Overflow (l/s)	Pipe Flow (l/s)	Status	Level Exceeded
S23.000	S59	8.549	0.126	0.000	1.19		16.4	SURCHARGED	
S20.003	S50	8.470	0.646	0.000	1.13		131.5	SURCHARGED	
S24.000	S52	8.791	-0.091	0.000	0.32		17.8		OK
S20.004	S25	8.412	0.681	0.000	1.09		140.4	SURCHARGED	
S12.008	S24	8.302	0.661	0.000	2.27		488.1	SURCHARGED	
S12.009	SPI2	8.173	0.542	0.000	0.47		99.8	SURCHARGED	
S12.010	S51	8.170	0.550	0.000	0.54		99.8	SURCHARGED	
S12.011	SHW2	8.167	-0.010	0.000	0.07		97.7		OK*
S25.000	39a	8.712	0.255	0.000	0.21		2.8	SURCHARGED	
S25.001	S39	8.719	0.352	0.000	0.61		36.9	SURCHARGED	
S25.002	S40	8.656	0.448	0.000	0.72		43.2	SURCHARGED	
S26.000	S42	8.755	0.308	0.000	0.38		22.7	SURCHARGED	
S26.001	S43	8.729	0.433	0.000	0.51		30.4	SURCHARGED	

100 year Return Period Summary of Critical Results by Maximum Level (Rank 1) for PR-Storm

PN	US/MH Name	Water Level (m)	Surcharged Depth (m)	Flooded Volume (m <sup>3</sup> )	Flow / Overflow Cap. (l/s)	Pipe Flow (l/s)	Status	Level Exceeded
S26.002	S44	8.651	0.415	0.000	0.64	35.0	SURCHARGED	
S25.003	S41	8.577	0.520	0.000	1.15	89.5	SURCHARGED	
S27.000	S37	8.338	-0.009	0.000	0.24	9.6	OK	
S28.000	S59	8.329	0.084	0.000	0.23	8.5	SURCHARGED	
S27.001	S53	8.317	0.243	0.000	0.73	61.1	SURCHARGED	
S25.004	S27	8.206	0.417	0.000	1.62	134.6	SURCHARGED	
S25.005	S28	8.093	0.334	0.000	0.40	29.7	SURCHARGED	
S25.006	SPI3	8.092	0.352	0.000	0.40	29.8	SURCHARGED	
S25.007	S29	8.091	0.370	0.000	0.41	30.6	SURCHARGED	
S25.008	SHW3	8.090	-0.279	0.000	0.02	28.4	OK*	
S1.008	SHW4-POND	8.089	0.489	0.000	1.14	318.8	SURCHARGED*	
S1.009	S8	8.474	0.917	0.000	0.89	248.7	SURCHARGED	
S1.010	S60	8.908	1.508	0.000	0.57	159.3	SURCHARGED	
S29.000	S57	9.049	1.228	0.000	0.86	89.5	SURCHARGED	
S1.011	S9	9.015	1.764	0.000	0.32	68.5	SURCHARGED	
S1.012	S10-HB	9.014	1.773	0.000	0.13	33.4	SURCHARGED	

Maximum permissible discharge rate 33.4 l/s (QBAR)

101 year Return Period Summary of Critical Results by Maximum Level (Rank 1) for PR-Storm

Simulation Criteria

Areal Reduction Factor	1.000	Additional Flow - % of Total Flow	0.000
Hot Start (mins)	0	MADD Factor * 10m <sup>3</sup> /ha Storage	2.000
Hot Start Level (mm)	0	Inlet Coefficient	0.800
Manhole Headloss Coeff (Global)	0.500	Flow per Person per Day (l/per/day)	0.000
Foul Sewage per hectare (l/s)	0.000		

Number of Input Hydrographs	0	Number of Storage Structures	1
Number of Online Controls	1	Number of Time/Area Diagrams	0
Number of Offline Controls	0	Number of Real Time Controls	0

Synthetic Rainfall Details

Rainfall Model	FSR	Ratio R	0.350
Region	England and Wales	Cv (Summer)	0.750
M5-60 (mm)	18.000	Cv (Winter)	0.840
Margin for Flood Risk Warning (mm)			300.0
Analysis Timestep	2.5 Second	Increment (Extended)	
DTS Status			OFF
DVD Status			ON
Inertia Status			ON
Profile(s)		Summer and Winter	
Duration(s) (mins)	15, 30, 60, 120, 240, 360, 480, 960, 1440		
Return Period(s) (years)		1, 30, 100, 101	
Climate Change (%)		0, 0, 0, 20	

PN	US/MH Name	Storm	Return Period	Climate Change	First (X) Surcharge	First (Y) Flood	First (Z) Overflow	Overflow Act.
S1.000	S4a	15 Winter	101	+20%	101/15 Summer			
S1.001	S4	15 Winter	101	+20%	100/15 Summer			
S1.002	S5a	15 Winter	101	+20%	30/15 Winter			
S2.000	S38	15 Winter	101	+20%	30/15 Summer	101/15 Winter		
S2.001	S16	15 Winter	101	+20%	30/15 Summer			
S1.003	S5	15 Winter	101	+20%	30/15 Summer			
S3.000	S1	15 Winter	101	+20%	30/15 Winter	101/15 Winter		
S3.001	S2	15 Winter	101	+20%	30/15 Summer			
S3.002	S3	15 Winter	101	+20%	30/15 Summer	101/15 Winter		
S3.003	S11	15 Winter	101	+20%	30/15 Summer			
S4.000	S15	15 Winter	101	+20%	100/15 Winter			
S3.004	S12	15 Winter	101	+20%	30/15 Summer			
S3.005	S13	15 Winter	101	+20%	30/15 Summer			
S1.004	S6	15 Winter	101	+20%	30/15 Summer			
S1.005	SPI1	480 Winter	101	+20%	30/15 Summer			
S1.006	S7	480 Winter	101	+20%	30/15 Summer			
S1.007	SHW1	60 Winter	101	+20%	30/15 Summer			
S5.000	R15	15 Winter	101	+20%	30/15 Summer			
S5.001	R16	15 Winter	101	+20%	30/15 Summer			

101 year Return Period Summary of Critical Results by Maximum Level (Rank 1) for PR-Storm

PN	US/MH Name	Water		Surcharged		Flooded		Pipe Flow (l/s)	Status	Level Exceeded
		Level (m)	Depth (m)	Volume (m³)	Flow / Cap. (l/s)	Overflow (l/s)				
S1.000	S4a	9.097	0.429	0.000	0.26	21.5	SURCHARGED			
S1.001	S4	9.074	0.675	0.000	0.67	47.1	SURCHARGED			
S1.002	S5a	8.990	0.823	0.000	0.96	67.2	SURCHARGED			
S2.000	S38	9.071	0.901	0.038	0.41	16.3	FLOOD	1		
S2.001	S16	9.043	1.053	0.000	0.95	32.1	FLOOD RISK			
S1.003	S5	8.789	1.065	0.000	2.03	117.4	SURCHARGED			
S3.000	S1	9.480	0.902	2.153	0.83	33.9	FLOOD	1		
S3.001	S2	9.466	1.248	0.000	0.66	44.4	FLOOD RISK			
S3.002	S3	9.399	1.298	0.002	1.07	58.9	FLOOD			
S3.003	S11	9.326	1.287	0.000	1.79	106.7	FLOOD RISK			
S4.000	S15	8.877	0.371	0.000	0.23	3.1	SURCHARGED			
S3.004	S12	8.886	0.989	0.000	2.08	104.8	SURCHARGED			
S3.005	S13	8.713	0.852	0.000	1.24	134.3	SURCHARGED			
S1.004	S6	8.372	0.745	0.000	3.40	271.4	SURCHARGED			
S1.005	SPI1	8.363	0.759	0.000	0.66	52.9	SURCHARGED			
S1.006	S7	8.362	0.780	0.000	0.54	52.5	SURCHARGED			
S1.007	SHW1	7.567	0.117	0.000	3.18	207.2	SURCHARGED*			
S5.000	R15	9.491	0.893	0.000	1.11	37.4	FLOOD RISK			
S5.001	R16	9.165	0.819	0.000	2.33	65.7	SURCHARGED			

Norwood House  
 96-102 Great Victoria Street  
 Belfast, BT2 7BE



Date 09/07/2021 12:09  
 File 202018 - MD - 210611.MDX

Designed by 645  
 Checked by

Innovyze Network 2019.1

101 year Return Period Summary of Critical Results by Maximum Level (Rank 1) for PR-Storm

PN	US/MH Name	Storm	Return Period	Climate Change	First (X) Surchage	First (Y) Flood	First (Z) Overflow	Overflow Act.
S6.000	R1	15 Winter	101	+20%	30/15 Summer	101/15 Summer		
S6.001	R2	15 Winter	101	+20%	30/15 Summer	101/15 Winter		
S7.000	R12	15 Winter	101	+20%	100/15 Summer			
S6.002	R3	15 Winter	101	+20%	30/15 Summer			
S6.003	R4	15 Winter	101	+20%	30/15 Summer			
S8.000	R13	15 Winter	101	+20%	30/15 Summer	101/15 Summer		
S8.001	R14	15 Winter	101	+20%	30/15 Summer			
S6.004	R5	15 Winter	101	+20%	30/15 Summer			
S5.002	R6	15 Winter	101	+20%	30/15 Summer			
S5.003	R7	15 Winter	101	+20%	30/15 Summer			
S5.004	R8	15 Winter	101	+20%	30/15 Summer			
S5.005	R9	15 Winter	101	+20%	30/15 Summer			
S5.006	R10	480 Winter	101	+20%	30/15 Summer			
S9.000	R17	15 Winter	101	+20%	30/15 Summer	101/15 Summer		
S9.001	R18	15 Winter	101	+20%	30/15 Summer	101/15 Winter		
S9.002	R19	15 Winter	101	+20%	30/15 Summer			
S10.000	R24	15 Winter	101	+20%	30/15 Summer	100/15 Winter		
S10.001	R25	15 Winter	101	+20%	30/15 Summer			
S9.003	R20	15 Winter	101	+20%	30/15 Summer			
S11.000	R26-HT	15 Winter	101	+20%	30/15 Winter			
S9.004	R21	15 Winter	101	+20%	30/15 Summer			
S9.005	R22	15 Winter	101	+20%	30/15 Summer			
S9.006	R23a	15 Winter	101	+20%	30/15 Summer			
S9.007	R23	480 Winter	101	+20%	30/15 Summer			
S5.007	R11	480 Winter	101	+20%	30/15 Summer			
S5.008	RHW1	60 Winter	101	+20%	30/15 Summer			
S12.000	S55	15 Winter	101	+20%	100/15 Summer	101/15 Winter		
S13.000	60	15 Winter	101	+20%	30/15 Summer	101/15 Winter		
S12.001	SJ2	60 Winter	101	+20%	30/15 Summer			
S14.000	S61	15 Winter	101	+20%	30/15 Winter	101/15 Winter		
S12.002	S56	15 Winter	101	+20%	30/15 Summer			
S12.003	S18	15 Winter	101	+20%	30/15 Summer	101/15 Winter		
S15.000	S30	15 Winter	101	+20%	30/15 Summer	101/15 Winter		
S12.004	S20	15 Winter	101	+20%	30/15 Summer			
S12.005	S21	15 Winter	101	+20%	30/15 Summer			
S16.000	S31	15 Winter	101	+20%	100/15 Winter			
S12.006	S22	15 Winter	101	+20%	30/15 Summer			
S17.000	S32	15 Winter	101	+20%	30/15 Summer			
S17.001	S33-3WV	15 Winter	101	+20%	30/15 Summer			
S12.007	S23	15 Winter	101	+20%	30/15 Summer			
S18.000	S34	15 Winter	101	+20%				
S19.000	S36	15 Winter	101	+20%				
S18.001	S35	15 Winter	101	+20%	100/15 Winter			
S20.000	S46	15 Winter	101	+20%	100/15 Summer	101/15 Winter		
S21.000	S54	15 Winter	101	+20%	100/15 Summer			
S20.001	S48	15 Winter	101	+20%	30/15 Summer			
S22.000	S61	15 Winter	101	+20%	100/15 Winter			
S20.002	S49	15 Winter	101	+20%	30/15 Summer			



Norwood House  
96-102 Great Victoria Street  
Belfast, BT2 7BE



Date 09/07/2021 12:09  
File 202018 - MD - 210611.MDX

Designed by 645  
Checked by

Innovyze

Network 2019.1

101 year Return Period Summary of Critical Results by Maximum Level (Rank 1) for PR-Storm

PN	US/MH Name	Water Level (m)	Surcharged Depth (m)	Flooded Volume (m <sup>3</sup> )	Flow / Cap. (l/s)	Overflow (l/s)	Pipe Flow (l/s)	Status	Level Exceeded
S6.000	R1	9.592	0.901	1.001	1.67		22.7	FLOOD	4
S6.001	R2	9.393	0.827	1.791	0.84		32.8	FLOOD	1
S7.000	R12	9.494	0.819	0.000	0.82		31.4	FLOOD RISK	
S6.002	R3	9.410	1.024	0.000	0.79		52.5	FLOOD RISK	
S6.003	R4	9.329	1.061	0.000	0.87		60.0	FLOOD RISK	
S8.000	R13	9.451	0.902	1.476	1.37		19.2	FLOOD	4
S8.001	R14	9.311	0.998	0.000	1.09		36.3	FLOOD RISK	
S6.004	R5	9.246	1.148	0.000	1.70		97.7	FLOOD RISK	
S5.002	R6	8.978	0.972	0.000	1.67		158.4	SURCHARGED	
S5.003	R7	8.724	0.809	0.000	2.12		158.5	SURCHARGED	
S5.004	R8	8.563	0.690	0.000	1.64		201.3	SURCHARGED	
S5.005	R9	8.405	0.589	0.000	2.35		200.1	SURCHARGED	
S5.006	R10	8.366	0.579	0.000	0.38		51.0	SURCHARGED	
S9.000	R17	9.421	0.827	1.831	0.80		31.7	FLOOD	4
S9.001	R18	9.420	1.043	0.016	1.64		51.8	FLOOD	1
S9.002	R19	9.274	0.961	0.000	1.59		48.0	FLOOD RISK	
S10.000	R24	9.499	0.902	2.381	1.53		21.4	FLOOD	5
S10.001	R25	9.187	0.821	0.000	2.22		24.2	FLOOD RISK	
S9.003	R20	9.117	0.863	0.000	2.59		65.7	SURCHARGED	
S11.000	R26-HT	8.919	0.447	0.000	0.17		2.1	SURCHARGED	
S9.004	R21	8.915	0.683	0.000	2.75		68.2	SURCHARGED	
S9.005	R22	8.729	0.518	0.000	1.19		69.1	SURCHARGED	
S9.006	R23a	8.631	0.520	0.000	2.04		113.1	SURCHARGED	
S9.007	R23	8.365	0.321	0.000	0.41		24.2	SURCHARGED	
S5.007	R11	8.362	0.718	0.000	0.59		80.4	SURCHARGED	
S5.008	RHW1	7.630	0.116	0.000	2.64		286.0	FLOOD RISK*	
S12.000	S55	9.509	0.828	3.142	0.99		33.5	FLOOD	2
S13.000	60	9.674	0.819	0.121	1.63		51.3	FLOOD	1
S12.001	SJ2	8.805	0.252	0.000	1.02		37.3	SURCHARGED*	
S14.000	S61	9.479	0.901	1.457	1.46		19.9	FLOOD	2
S12.002	S56	9.505	1.078	0.000	0.62		85.9	FLOOD RISK	
S12.003	S18	9.385	1.105	0.273	1.19		204.2	FLOOD	1
S15.000	S30	9.503	0.825	0.355	1.42		56.8	FLOOD	1
S12.004	S20	9.251	1.174	0.000	2.06		250.6	FLOOD RISK	
S12.005	S21	9.074	1.051	0.000	2.09		239.3	FLOOD RISK	
S16.000	S31	8.940	0.355	0.000	0.72		10.1	SURCHARGED	
S12.006	S22	8.902	0.925	0.000	1.29		249.1	SURCHARGED	
S17.000	S32	9.336	0.374	0.000	2.36		64.5	FLOOD RISK	
S17.001	S33-3WV	9.123	0.175	0.000	2.19		64.1	SURCHARGED	
S12.007	S23	8.725	0.851	0.000	2.36		305.1	SURCHARGED	
S18.000	S34	9.238	-0.289	0.000	0.27		104.6	OK	
S19.000	S36	9.627	-0.173	0.000	0.12		10.9	OK	
S18.001	S35	8.771	0.383	0.000	0.37		137.8	SURCHARGED	
S20.000	S46	9.178	0.825	0.074	0.76		54.4	FLOOD	1
S21.000	S54	9.250	0.772	0.000	1.37		113.2	FLOOD RISK	
S20.001	S48	9.069	1.050	0.000	1.39		128.5	FLOOD RISK	
S22.000	S61	8.948	0.411	0.000	0.08		2.9	SURCHARGED	

Doran Consulting Limited		Page 44
Norwood House 96-102 Great Victoria Street Belfast, BT2 7BE		
Date 09/07/2021 12:09 File 202018 - MD - 210611.MDX	Designed by 645 Checked by	
Innovyze		Network 2019.1

101 year Return Period Summary of Critical Results by Maximum Level (Rank 1) for PR-Storm

PN	US/MH Name	Water Level (m)	Surcharged Depth (m)	Flooded Volume (m <sup>3</sup> )	Flow / Overflow Cap. (l/s)	Pipe Flow (l/s)	Status	Level Exceeded
S20.002	S49	8.948	1.002	0.000	1.06	140.8	FLOOD RISK	

101 year Return Period Summary of Critical Results by Maximum Level (Rank 1) for PR-Storm

PN	US/MH Name	Storm	Return Period	Climate Change	First (X) Surcharge	First (Y) Flood	First (Z) Overflow	Overflow Act.
S23.000	S59	15 Winter	101	+20%	100/15 Summer			
S20.003	S50	15 Winter	101	+20%	30/15 Summer			
S24.000	S52	15 Winter	101	+20%				
S20.004	S25	15 Winter	101	+20%	30/15 Summer			
S12.008	S24	15 Winter	101	+20%	30/15 Summer			
S12.009	SPI2	480 Winter	101	+20%	30/15 Summer			
S12.010	S51	480 Winter	101	+20%	30/15 Summer			
S12.011	SHW2	360 Winter	101	+20%				
S25.000	39a	15 Winter	101	+20%	100/15 Summer			
S25.001	S39	15 Winter	101	+20%	100/15 Summer			
S25.002	S40	15 Winter	101	+20%	30/15 Summer			
S26.000	S42	15 Winter	101	+20%	100/15 Summer			
S26.001	S43	15 Winter	101	+20%	30/15 Winter			
S26.002	S44	15 Winter	101	+20%	30/15 Winter			
S25.003	S41	15 Winter	101	+20%	30/15 Summer			
S27.000	S37	15 Winter	101	+20%	101/15 Summer			
S28.000	S59	15 Winter	101	+20%	100/15 Summer			
S27.001	S53	15 Winter	101	+20%	30/15 Winter			
S25.004	S27	15 Winter	101	+20%	30/15 Summer			
S25.005	S28	480 Winter	101	+20%	30/15 Summer			
S25.006	SPI3	480 Winter	101	+20%	30/15 Summer			
S25.007	S29	480 Winter	101	+20%	30/15 Summer			
S25.008	SHW3	480 Winter	101	+20%				
S1.008	SHW4-POND	480 Winter	101	+20%	30/120 Summer			
S1.009	S8	240 Winter	101	+20%	30/60 Winter			
S1.010	S60	480 Winter	101	+20%	30/30 Winter			
S29.000	S57	240 Winter	101	+20%	30/15 Winter			
S1.011	S9	240 Winter	101	+20%	30/15 Summer			
S1.012	S10-HB	240 Winter	101	+20%	30/15 Summer			

PN	US/MH Name	Water Level (m)	Surcharged Depth (m)	Flooded Volume (m³)	Flow / Cap. (l/s)	Overflow (l/s)	Pipe Flow (l/s)	Status	Level Exceeded
S23.000	S59	8.917	0.494	0.000	1.30		17.9	SURCHARGED	
S20.003	S50	8.807	0.983	0.000	1.34		156.1	SURCHARGED	
S24.000	S52	8.797	-0.085	0.000	0.39		21.4	OK	
S20.004	S25	8.725	0.994	0.000	1.29		167.1	SURCHARGED	
S12.008	S24	8.573	0.932	0.000	2.68		574.6	SURCHARGED	
S12.009	SPI2	8.361	0.730	0.000	0.57		122.0	SURCHARGED	
S12.010	S51	8.360	0.739	0.000	0.66		122.1	SURCHARGED	
S12.011	SHW2	8.177	0.000	0.000	0.11		142.3	SURCHARGED*	
S25.000	39a	9.135	0.678	0.000	0.29		3.9	FLOOD RISK	
S25.001	S39	9.138	0.771	0.000	0.69		41.4	FLOOD RISK	
S25.002	S40	9.066	0.858	0.000	0.82		48.8	SURCHARGED	
S26.000	S42	9.160	0.713	0.000	0.41		24.3	FLOOD RISK	
S26.001	S43	9.125	0.830	0.000	0.56		33.6	FLOOD RISK	

101 year Return Period Summary of Critical Results by Maximum Level (Rank 1) for PR-Storm

PN	US/MH Name	Water Level (m)	Surcharged Depth (m)	Flooded Volume (m <sup>3</sup> )	Flow / Overflow Cap. (l/s)	Pipe Flow (l/s)	Status	Level Exceeded
S26.002	S44	9.046	0.810	0.000	0.76	41.8	SURCHARGED	
S25.003	S41	8.972	0.915	0.000	1.36	106.5	SURCHARGED	
S27.000	S37	8.610	0.263	0.000	0.25	10.0	SURCHARGED	
S28.000	S59	8.600	0.355	0.000	0.25	9.4	SURCHARGED	
S27.001	S53	8.584	0.510	0.000	0.76	63.7	SURCHARGED	
S25.004	S27	8.453	0.664	0.000	1.97	163.9	SURCHARGED	
S25.005	S28	8.374	0.615	0.000	0.50	37.4	SURCHARGED	
S25.006	SPI3	8.372	0.632	0.000	0.51	38.3	SURCHARGED	
S25.007	S29	8.371	0.650	0.000	0.53	39.5	SURCHARGED	
S25.008	SHW3	8.369	0.000	0.000	0.03	36.3	OK*	
S1.008	SHW4-POND	8.359	0.759	0.000	1.44	400.9	SURCHARGED*	
S1.009	S8	8.672	1.115	0.000	1.08	303.9	SURCHARGED	
S1.010	S60	9.294	1.894	0.000	0.65	179.5	SURCHARGED	
S29.000	S57	9.419	1.598	0.000	1.18	122.7	FLOOD RISK	
S1.011	S9	9.403	2.152	0.000	0.37	77.8	SURCHARGED	
S1.012	S10-HB	9.401	2.160	0.000	0.13	33.4	FLOOD RISK	

**Maximum permissible discharge rate 33.4 l/s (QBAR)**



## APPENDIX F:

Rev.	Date	By	Check	Details	Appr.
P01	09.02.21	OC	EF	First Issue	PGK
P02	28.01.22	BMcC	AC	Extent of flooding updated to suit revised site layout.	PGK
P03	25.03.22	BMcC	AC	Site layout amended.	PGK

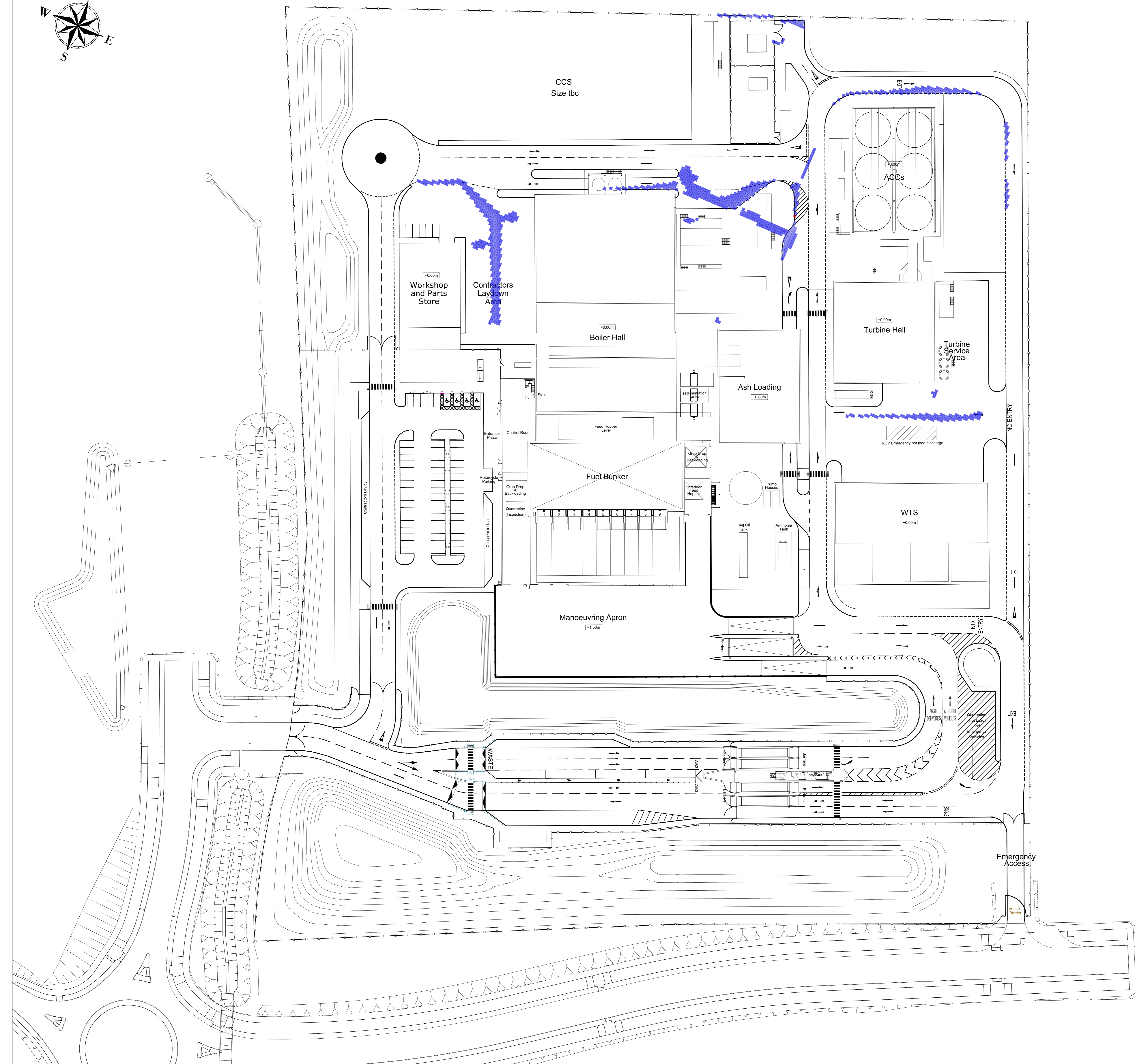
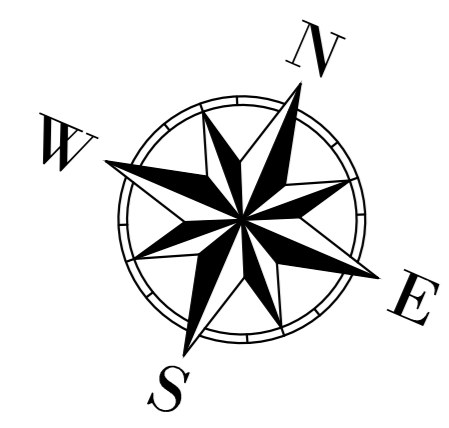

**Legend**  
 [Blue Hatched Box] Extent of Flooding Q100 +30% Climate Change

Status	Date	By	Check	Drawing Status	Details	Appr.

**PRELIMINARY DRAWING**

Project Title:  
TEES VALLEY EFW

Drawing Title:  
Proposed Drainage  
Extent of Flooding  
Q100 +30% Climate Change

Client/Architect: HZI  
 Drawn by: OC Date: June '21  
 Checked by: EF Scales: 1:500  
 Approved by: PGK Sheet Size: A0

Project Number	Orig	Zone	Level	Type	Disc	Number	Revision
212018	DC	XX	XX	GA	C	303	P03

**Doran CONSULTING**  
 DELIVERING ENGINEERING EXCELLENCE  
 Nowwood House  
 88-100 Great Victoria Street,  
 Belfast BT2 7BE  
 T: 028 90333443  
 F: 028 90205001  
 E: mail@doran.co.uk  
 W: www.doran.co.uk



## APPENDIX G:

Drainage Component	Maintenance Responsibility	Maintenance Activity	Regularity	Date of Inspection/Maintenance	Inspected/Maintained by	Details of Inspection/Maintenance and any other Comments
Permeable Paving Systems	Site Operator	Surface brushing and vaccuming for appearance and to reduce silt accumulation	Monthly			
		Check outlets and control structures	Monthly depending on detail			
		Initial inspection	Monthly for three months after installation			
		Inspect for evidence of poor operations and/or weed growth. If required take remedial action.	Every three months or 48 hrs after large storms			
		Inspect silt accumulation rates and establish appropriate brushing frequencies	Annually			
		Monitor inspection chambers	Annually			
		Wash, particularly in autumn after leaf fall	Annually			
		Mow grass edges to paving at 35-50mm and remove weeds and leaves	Fortnightly in season or As required			
		Jetting and suction where silt has accumulated in joints or voids. Replace grit and vibrate surface to lock for permeable block paving	Every 2 years or As required			
		Where sinkage or surface damage occurs, uplift blocks, remove grit bedding layer, geotextile if present and reinstate to design profile	As required			
Gullies	Site Operator	Litter and debris removal	Monthly or As required			
Drainage Channels	Site Operator	Litter and debris rmove	Montthly or As required			
		Jet cleaning along channel	Biannually or after significant storm event			
Silt Pits	Site Operator	Assess the depth of accumulated oil and silt	Monthly or after significant storm event			
		Remove accumulated silt from bases of pits and dispose of inappropriate manner	Biannually or after significant storm event			
Oil/Petrol Interceptors	Site Operator	Physically inspect the integrity of the separator and any mechanical parts	Biannually or after significant storm event			
		Assess the depth of accumulated oil and silt	Biannually or after significant storm event			
		Service all electrical equipment such as alarms and separator management systems	Biannually or after significant storm event			
		Check the condition of any coalescing device and replace it if necessary	Biannually or after significant storm event			



Drainage Component	Maintenance Responsibility	Maintenance Activity	Regularity	Date of Inspection/Maintenance	Inspected/Maintained by	Details of Inspection/Maintenance and any other Comments
		Remove litter and debris and inspect for sediment, oil and grease accumulation	Biannually or after significant storm event/spillage			
		Inspect for evidence of poor operation	Biannually			
		Inspect sediment accumulation rate and establish appropriate removal frequencies	Monthly during first six months of operations, then biannually			
Vortex Flow Control Chamber	Site Operator	Assess the depth of accumulated oil and silt	Monthly or after significant storm event			
		Remove accumulated silt from chamber and dispose of in appropriate manner	Biannually or after significant storm event			
Vortex Flow Control Unit	Site Operator	Assess for wear of parts or damage to inlet/outlet	Biannually or after significant storm event			
		Assess for any evidence of blockage or poor operation	Biannually or after significant storm event			
Attenuation Basin	Site Operator	Remove litter and debris	Monthly			
		Cut grass - for spillways and access routes	Monthly during growing season or As required			
		Cut grass - meadow grass in an around basin	Biannually (Spring - before nesting season, and Autumn)			
		Manage other vegetation and remove nuisance plants	Monthly at start then As required			
		Inspect inlets, outlets and overflows for blockages, and clear if required	Monthly			
		Inspect banksides, structures, pipework etc for evidence of physical damage	Monthly			
		Inspect inlets and facility surface for silt accumulation. Establish appropriate silt removal frequencies.	Monthly (for first year) then As required			
		Check any penstocks and other mechanical devices	Annually			
		Tidy all dead growth before start of growing season	Annually			
		Remove sediments from inlets, outlet and forebay	Annually or As required			
		Reseed areas of poor vegetation growth	As required			
		Prune and trim any trees and remove cuttings	Every 2 years or As required			
Remove sediments from inlets, outlets, forebay and main basin when required	Every 5 years or As required					

Drainage Component	Maintenance Responsibility	Maintenance Activity	Regularity	Date of Inspection/Maintenance	Inspected/Maintained by	Details of Inspection/Maintenance and any other Comments
		Repair erosion or other damage by reseeding or returfing	As required			
		Repair/rehabilitation of inlets, outlets and overflows	As required			
		Relevel uneven surfaces and reinstate design levels	As required			
Rainwater Harvesting Tank	Site Operator	Inspection of tank for debris and sediment build-up, inlets/outlets/withdrawal devices, overflow areas, pumps, filters	Annually and following poor performance			
		Cleaning of tank, inlets, outlets, gutters, withdrawal devices and roof drain filters of silts and other debris	Annually and following poor performance			
		Cleaning and/or replacement of any filters	Quarterly or As required			
		Repair of overflow erosion damage or damage to tank	As required			
		Pump repairs	As required			
Dump Tank	Site Operator	Inspection of tank for debris and sediment build-up, inlets/outlets	Annually and following poor performance			
		Cleaning of tank, inlets, outlets of silts and other debris	Annually and following poor performance			
		Removal of spent firefighting water	As required/after any firefighting event			